

BUY IN PRINT [WORLDWIDE MAGPI.CC/STORE](http://WORLDWIDE.MAGPI.CC/STORE)

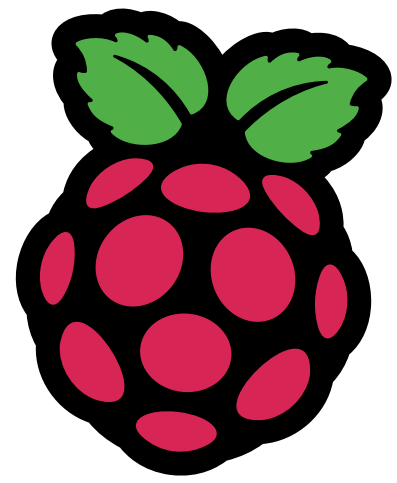

The MagPi



Issue 124 | December 2022 | magpi.cc

The official Raspberry Pi magazine

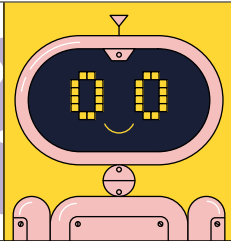
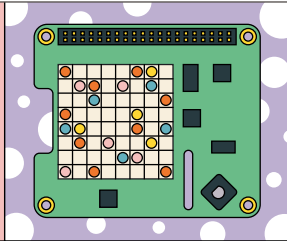
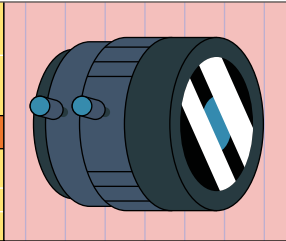
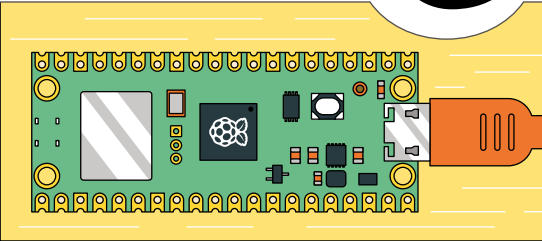
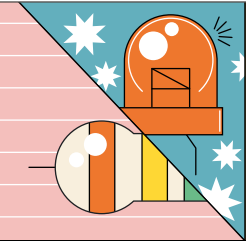

**CODE
HANDHELD
GAMES**

RASPBERRY PI BUYERS GUIDE

2023

ULTIMATE GUIDE TO HARDWARE,
ACCESSORIES & PROJECT KITS

**HACK
RETRO
TV/VCR**

**TOP 10
XMAS
PROJECTS**

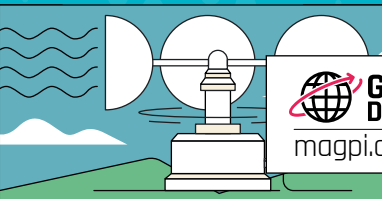
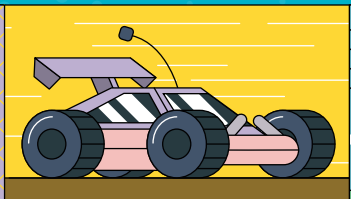
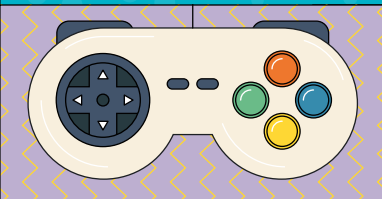

 **GLOBAL DELIVERY**
magpi.cc/store

 **Raspberry Pi PRESS**

BUILD A **MAKER ROOM** AT HOME





Industrial Raspberry Pi

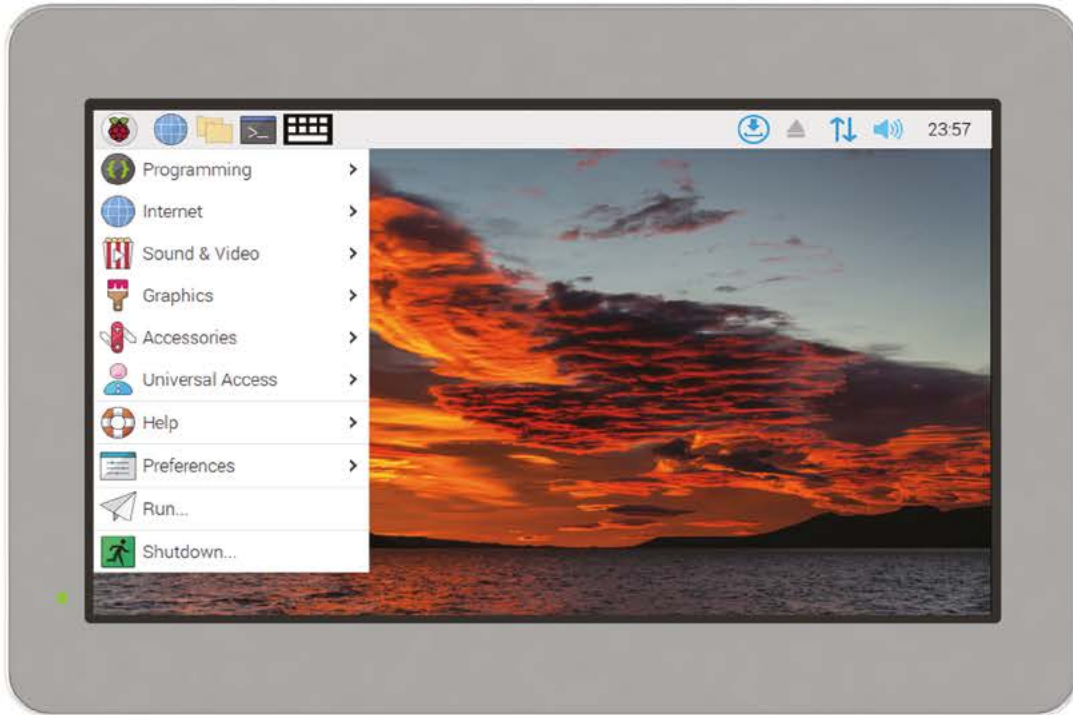

ComfilePi

The ComfilePi is a touch panel PC designed with high-tolerant components and no moving parts for industrial applications. It features a water-resistant front panel, touchscreen, color LCD (available in various sizes), RS-232, RS-485, Ethernet, USB, I2C, SPI, digital IO, battery-backed RTC (real-time clock), and piezo buzzer.

Use the rear-panel 40-pin GPIO header to expand its features and capabilities with additional I/O boards. The ComfilePi is UL Listed and employs Raspberry Pi Compute Module.

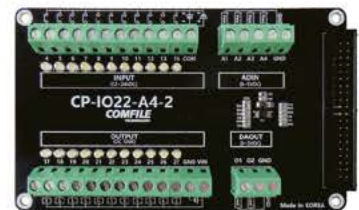

WELCOME

to *The MagPi* 124

It may be true that money can't buy you happiness, but it can buy you small computing and maker projects, which is a pretty good substitute.

We love the holiday season and what better time to gift something you love, from yourself (and probably to yourself)? This month, we have put together our guide to buying Raspberry Pi and the best Raspberry Pi kit you can find (**page 36**).

We've also got our guide to turning a spare space into a maker room (**page 66**). Between the two, this month you can turn a hectic holiday season into a time of pure bliss. Making and crafting your own electronic projects in a space of your own.

At least that's the plan. Good luck!

Lucy Hattersley Editor



EDITOR Lucy Hattersley

Lucy is editor of *The MagPi* and is sitting out of the pouring rain with a coffee in a hipster train pub. The electronic timetable is running on Raspberry Pi. She might just settle in.

magpi.cc

GET A
RASPBERRY PI PICO W
WITH A SUBSCRIPTION!
PAGE 34



Explore E-ink technology with **EPDK** from **PERVASIVEDISPLAYS** **E-paper display (EPD) Pico Development Kit**

The EPD Pico Development Kit from Pervasive Displays includes everything to start exploring E-ink technology.

- ⇒ EPD Extension board Gen 3 (EXT3-1) board
- ⇒ Raspberry Pi Pico RP2040 (with pin header)
- ⇒ 2.66" E-ink Monochrome Display with Fast Update
- ⇒ 20-pins and 2-pins bridging cable
- ⇒ Pin mapping label (3 pieces)

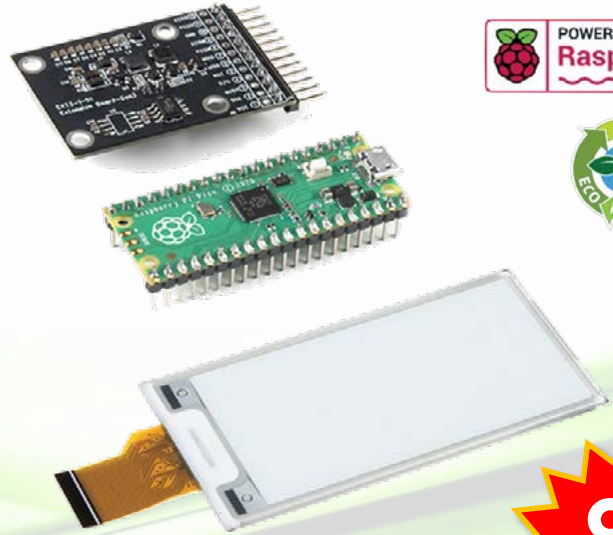
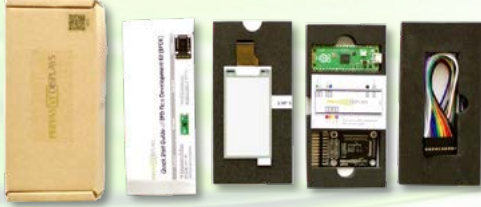

Grab a USB cable, download the library and start exploring E-ink technology today!

Learn more **PERVASIVEDISPLAYS**
www.pervasivedisplays.com



Buy it **sparkfun**
ELECTRONICS
www.sparkfun.com/products/19219



Entaniya Cube Case 01 for Single Board Computers

Cube Case 01 provides safe housing for main units of Single Board Computers, e.g. Raspberry Pi 3 or 4. It has a high-quality machined aluminum frame, with many options such as interchangeable acrylic panels and perforated panels that allow cables to pass through.

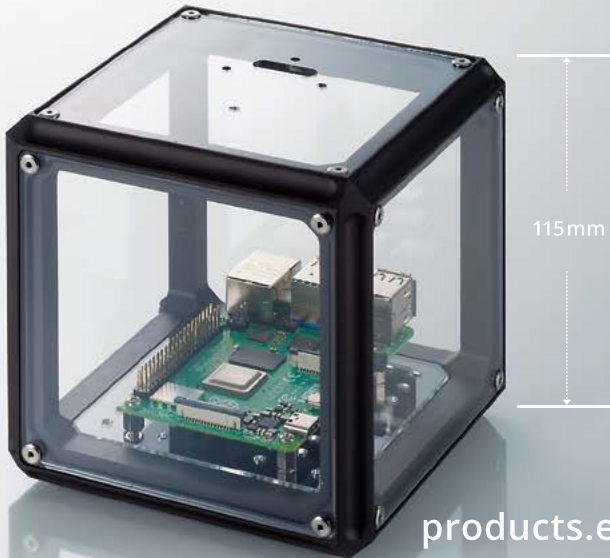

products.entaniya.co.jp/en/

Dustproof and drip-proof in use with the included sealing mats



A free configurable case with replaceable panels



Compatible with Entaniya All-Weather Case WC-01 for Raspberry Pi Camera Module 2 (sold separately)



For inquiries, please contact products@entaniya.co.jp

Entaniya Co.,Ltd., Nishiwaseda 2-5-13, Shinjuku-Ku, Tokyo 169-0051, Japan | www.entaniya.co.jp

Contents

> Issue 124 > December 2022

Cover Feature

36 Raspberry Pi Buyers Guide 2023

Regulars

- 32** Case Study: KwickPOS
- 92** Your Letters
- 97** Next Month
- 98** The Final Word

Project Showcases

- 08** CRT TV + VCR Trinitron Retro Media Player
- 12** ForestryPi
- 16** HandiPi
- 18** The Lost Sounds Project
- 22** Automatic Fish Feeder Deluxe
- 24** CNC Drawing Machine
- 26** JägerMachine
- 28** Open Book Abridged Edition
- 30** Open-Source Gamma Detector

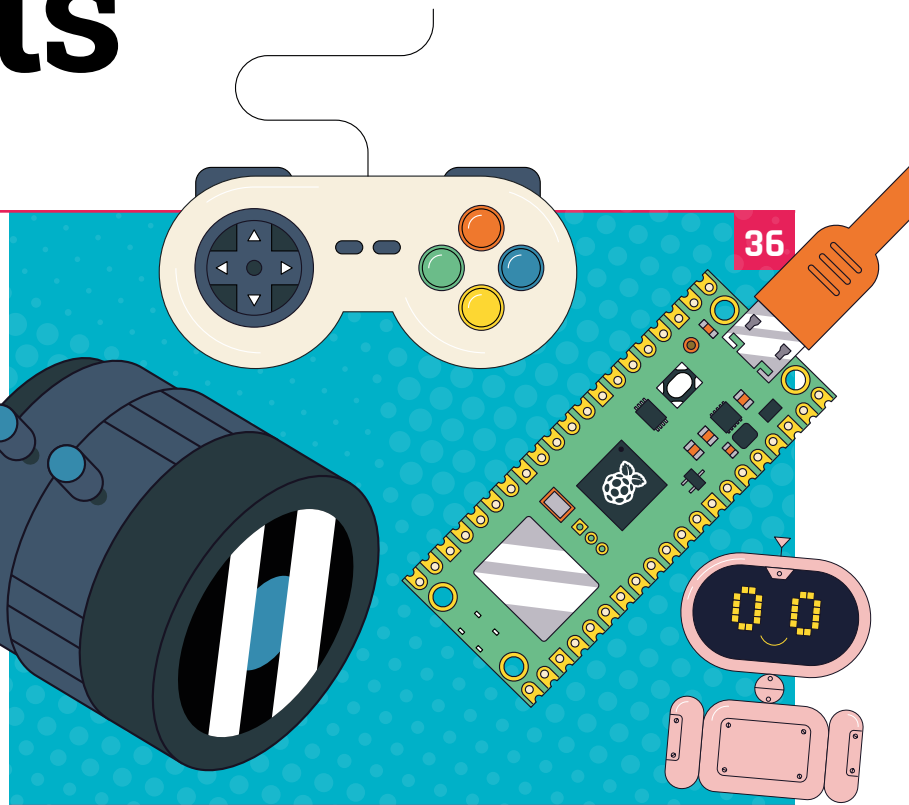

HandiPi

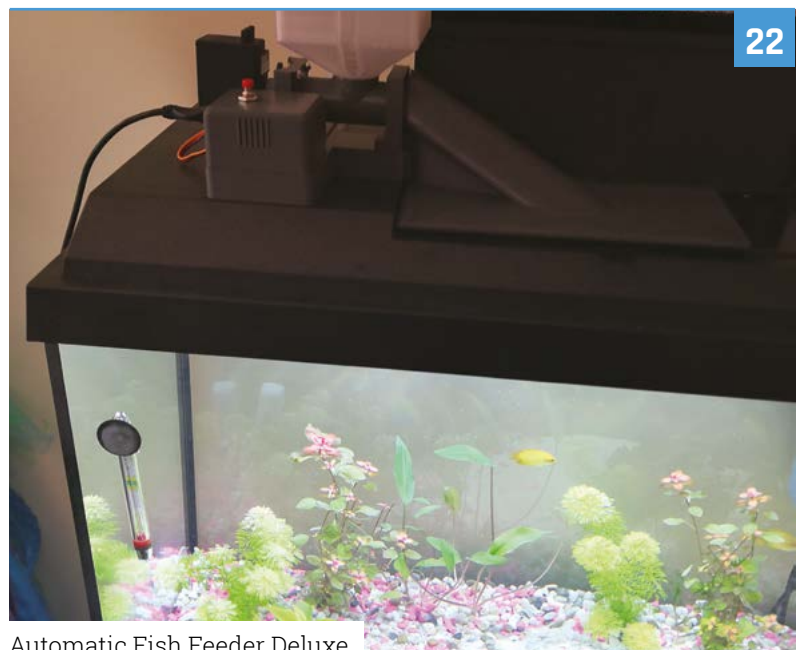

Automatic Fish Feeder Deluxe

The MagPi magazine is published monthly by Raspberry Pi Ltd. Publishers Service Associates, 2406 Reach Road, Williamsport, PA, 17701, is the mailing agent for copies distributed in the US. Application to mail at Periodicals prices is pending at Williamsport, PA. POSTMASTER: Send address changes to The MagPi magazine c/o Publishers Service Associates, 2406 Reach Road, Williamsport, PA, 17701.

Tutorials

- 46 Build a MicroPython handheld - part 2
- 50 Pico W IoT - plot sensor data
- 54 Iron Man Arc Reactor
- 60 How I made Ceres-1 Portable

The Big Feature



66

Create your own maker space



Iron Man Arc Reactor



How I made Ceres-1 Portable



72

SH080 8-inch mini HDMI screen

Reviews

- 72 SH080 8-inch mini HDMI screen
- 74 POP CAMERA
- 77 Inventor 2040 W
- 79 Motor 2040
- 81 Top 10 holiday projects
- 84 Learn to code games

Community

- 86 Toby Roberts interview
- 88 This Month in Raspberry Pi



86

Toby Roberts interview

WIN

A MICROPI
STARTER KIT



95

DISCLAIMER: Some of the tools and techniques shown in The MagPi magazine are dangerous unless used with skill, experience, and appropriate personal protection equipment. While we attempt to guide the reader, ultimately you are responsible for your own safety and understanding the limits of yourself and your equipment. Children should be supervised. Raspberry Pi Ltd does not accept responsibility for any injuries, damage to equipment, or costs incurred from projects, tutorials or suggestions in The MagPi magazine. Laws and regulations covering many of the topics in The MagPi magazine are different between countries, and are always subject to change. You are responsible for understanding the requirements in your jurisdiction and ensuring that you comply with them. Some manufacturers place limits on the use of their hardware which some projects or suggestions in The MagPi magazine may go beyond. It is your responsibility to understand the manufacturer's limits.

SELECTION STARTS HERE



More products. More name-brand suppliers.
More new product inventory. We simply have
more of what you need.

Find it at digikey.co.uk or call 0800 587 0991.



FREE SHIPPING ON ORDERS OVER £33 OR \$50 USD*

*A shipping charge of £12.00 will be billed on all orders of less than £33.00. A shipping charge of \$18.00 USD will be billed on all orders of less than \$50.00 USD. All orders are shipped via UPS, Federal Express, or DHL for delivery within 1-3 days (dependent on final destination). No handling fees. All prices are in British pound sterling or United States dollar. Digi-Key is a franchised distributor for all supplier partners. New products added daily. Digi-Key and Digi-Key Electronics are registered trademarks of Digi-Key Electronics in the U.S. and other countries. © 2022 Digi-Key Electronics, 701 Brooks Ave. South, Thief River Falls, MN 56701, USA

ECIA MEMBER
Supporting The Authorized Channel

CRT TV + VCR

Trinitron Retro Media Player

When Mairon Wolniewicz watches movies or plays games from the 1970s, 1980s, and 1990s, he ensures he gets the full retro experience, as **David Crookes** explains



Mairon Wolniewicz

Mairon is an Aerospace Engineer from Brazil. While most of his job is coding for satellites, he spends a lot of his free time tweaking configurations and writing scripts as a hobby.

github.com/MaironW

There is no doubt that a crisp, modern, flat display has been a blessing for our eyes, not to mention the space in our homes, schools, and offices. But if you're a retro enthusiast and you have old video games or movies from the last century, then you may want to go the whole hog and grab yourself a cathode-ray tube (CRT) television instead.

That's exactly what Mairon Wolniewicz has done, creating a media server based around a Raspberry Pi computer that outputs to an old Sony Trinitron CRT he picked up following months of searching. As it happens, these TVs were created in the Sony UK Technology Centre factory in Pencoed, south Wales, where Raspberry Pi is produced today, but Mairon was simply after a quality television set.

"I saw these were the best ever CRTs and one appeared out of nowhere with a built-in VCR," he says. "The seller didn't know if the VCR was working, but I wasn't bothered because my idea was to remove the mechanical parts that occupied the VCR space and use it to store the cables, power supply, and Raspberry Pi."

Picture perfect

In that sense, he had a bold plan. "Since the television only had composite and RF video inputs, I considered connecting the internal wirings of the

A/V plug – the ones on the front of the TV – into a Raspberry Pi RCA cable. It would involve cutting out the RCA connectors and soldering the wires directly to the TV," he adds. But then curiosity got the better of him and he bought a copy of *Shrek* on VHS. To his surprise, it worked!

He then resolved to revise his project, deciding, as a lover of retro, that he simply couldn't scrap the VCR element of the TV. Instead, he opted to place the Raspberry Pi 4 computer into a case that he clipped on to the grid at the back of the TV. He admits it's not the most elegant of solutions ("the composite inputs are on the front of the TV," he laments), but his retro media player could still make use of the CRT display.

So what has motivated him to do this? "Well, I've been spending a lot of time learning how to paint by watching videos by Bob Ross [an American painter and TV host who died in 1995], and I thought it would be cool to just let videos like these play in a loop on a small screen in my room," he explains. "Soon, I was also looking to add other functions. My Raspberry Pi came with SNES controllers, so playing games was inevitable."

Play it again

This is when the project took off. The setup was straightforward (videos and games are stored

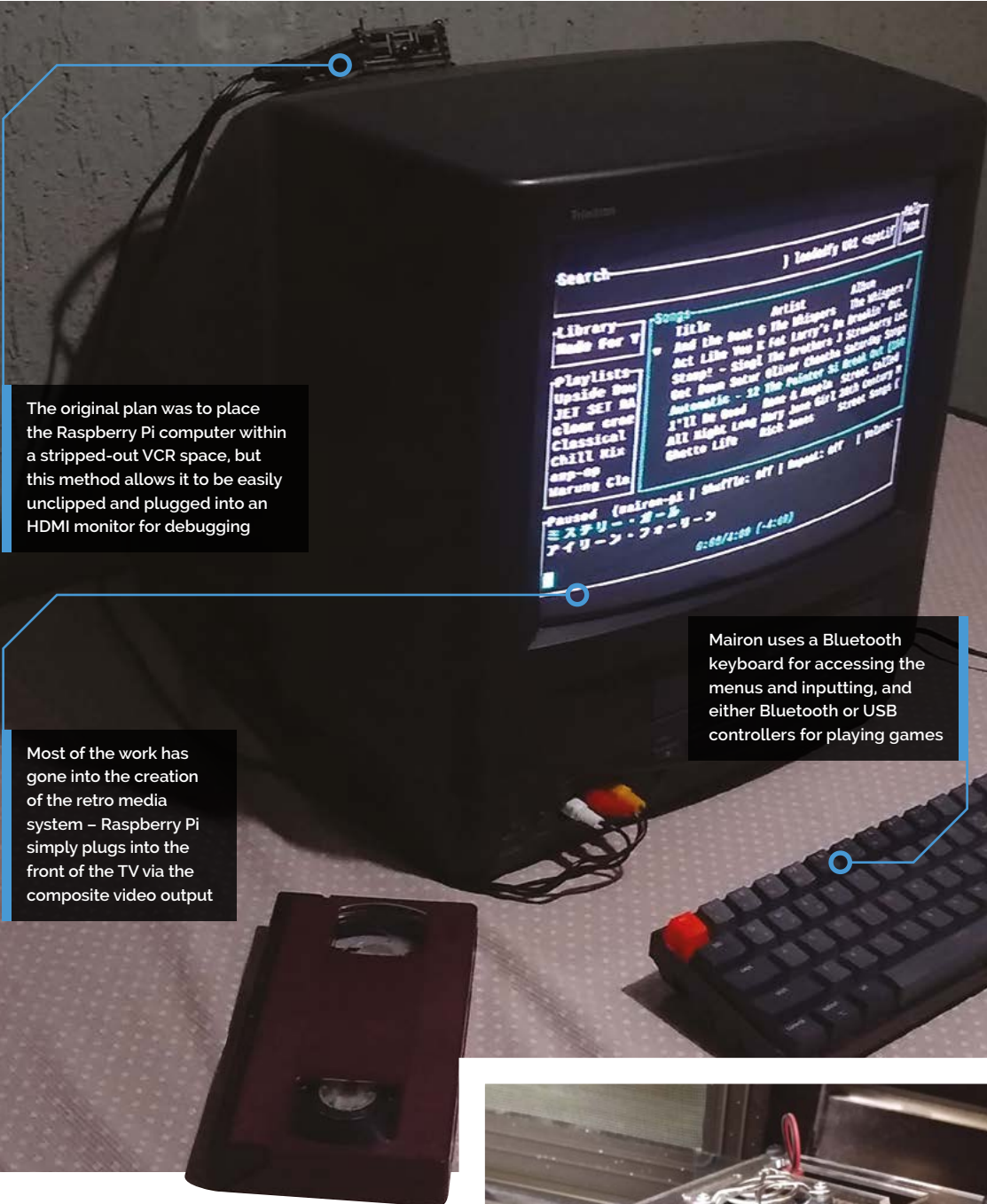

Quick FACTS

- ▶ The project uses a 14-inch CRT TV
- ▶ Videos can be chosen or played randomly
- ▶ The interface is inspired by those on VCRs
- ▶ Mairon wants to add audio effects
- ▶ It cost Mairon \$140 to make

The original plan was to place the Raspberry Pi computer within a stripped-out VCR space, but this method allows it to be easily unclipped and plugged into an HDMI monitor for debugging

Most of the work has gone into the creation of the retro media system – Raspberry Pi simply plugs into the front of the TV via the composite video output

Mairon uses a Bluetooth keyboard for accessing the menus and inputting, and either Bluetooth or USB controllers for playing games

“ I saw these were the best ever CRTs and one appeared out of nowhere with a built-in VCR ”

on a USB stick and video output is via a P3/RCA connector), but Mairon’s retro media system has a custom GUI resembling a VCR interface – complete with white text on a blue background.



▲ To keep Raspberry Pi in place and easily accessible, Mairon has made good use of the grill on the back of the TV

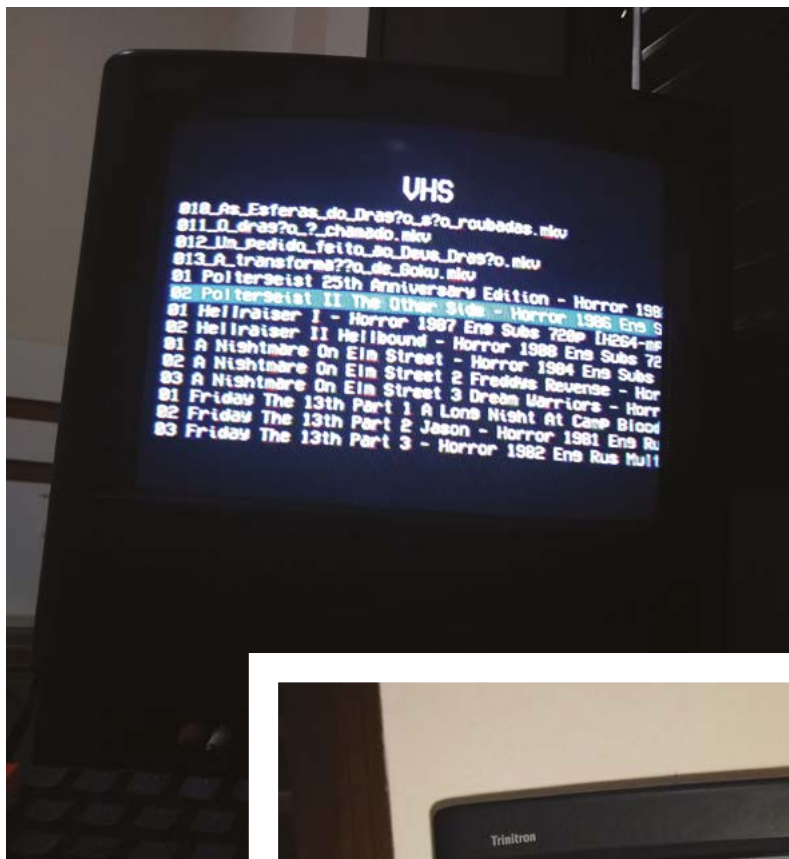

▲ It's not quite as polished as Kodi, but that's deliberate. It looks like Mairon loves 1980s horror flicks!

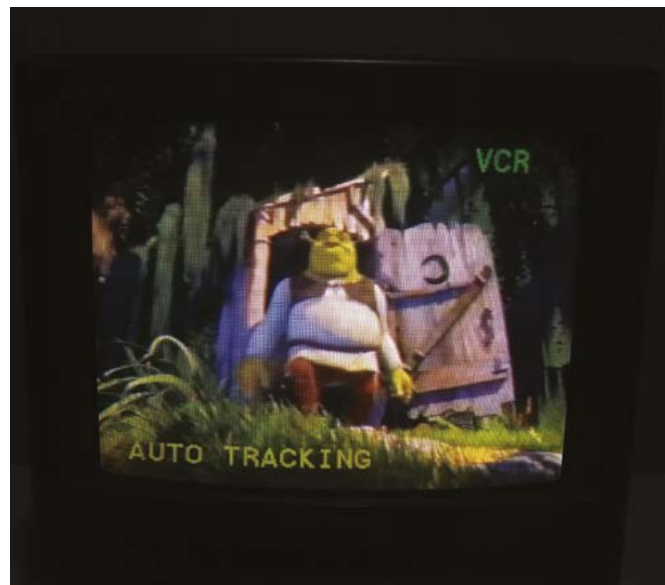

▲ Mairon's *Shrek* physical VHS tape playing perfectly on the TV – the reason why he didn't open up his TV (warning: don't forget that working inside old CRT televisions is dangerous)



▲ Mairon had been a long time user of RetroPie and EmulationStation, so decided to stick with it rather than create his own emulator/game selector



ALERT!
CRT

CRT monitors and televisions can carry lethal amounts of electrical charge. Be extremely careful when working with CRT-based technology.

magpi.cc/crt



“I thought it would be cool to have a GUI where I’d choose what I wanted to do with my media player, and I thought the VCR look would match nicely,” he says. This was accomplished using Qt QML, a declarative language for designing user

▲ This retro media system is fundamentally designed to be plug-and-play, with the software used to launch the correct applications

“ I thought it would be cool to just let videos play in a loop on a small screen ”

interfaces. “C++ was used for file reading and to launch Linux commands,” he adds.

Most of Mairon’s time has been spent tweaking Raspberry Pi configuration files. “It will run fine with composite output, on the desired resolution with legible font and without overscan,” he says. Indeed, the system is configured to output video to 480i, and it’s set up to correctly run music and games.

It’s navigated using the up/down arrow and **ENTER** keys on a keyboard, with the **BACKSPACE** key for returning to a previous menu. “I’d like the GUI to support gamepads, and I’d also like to integrate a personal assistant,” he says. “Sure, it’s not even close to retro, but wouldn’t it be cool to request your TV to play a season of an old show when you lie down on your bed?” **M**

Reliving the past



01 The VCR-inspired menu lets you navigate up and down to watch TV, play video games, or listen to music. ‘Exit’ was added because Mairon got bored of typing `sudo shutdown -h now`



02 As well as TV shows such as Bob Ross’s *The Joy of Painting*, Mairon can navigate to music videos, other series and movies, and random YouTube videos via **MyRetroTVs.com**.

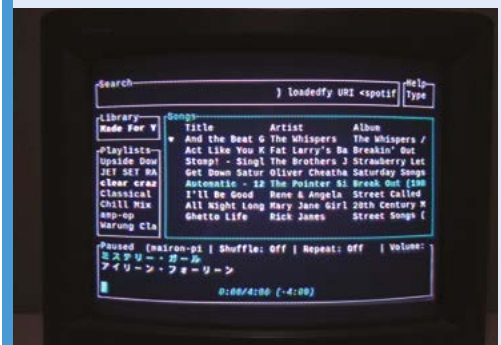

03 Homebrew retro games can be played via EmulationStation and the radio option launches Spotify TUI, a tool that allows Spotify streams to be controlled from the terminal.

ForestryPi

A professional arborist used Raspberry Pi hemispheric monitoring to observe trees across several seasons. **Rosie Hattersley** hears the story



Edward Lane

MAKER

Ed Lane learned about low-cost nature monitoring while studying and worked backward to create his own, albeit with “just disgusting” code.

magpi.cc/hemiphoto

▶ Weeding out the best photos, and using ImageJ to process them, produces some great results

With an established tree surgery business under their belts, Ed Lane and his brother decided to branch out into “proper forestry”, offering advice to larger clients such as farmers and landowners about the long-term health of their land. Obvious puns aside, adding hemispheric photographic monitoring to their list of services meant both clients and arborists could take a long-term look at how climate change was impacting stands of trees in their immediate vicinity. Having encountered Raspberry Pi at university, and through a general interest in technology, Ed chose it for Green Lane Forestry’s ForestryPi monitoring scheme, which quickly attracted several business customers.



In a further twist, Ed has recently handed over the tree surgery business to his brother and is currently training as a primary school teacher. He has taken one of his ForestryPi monitoring kits with him and will use it to inspire pupils as citizen scientists, reporting on the trees at school over the seasons and successive years.

“ He has taken one of his ForestryPi monitoring kits with him ”

International inspiration

Ed returned to university to study aquaculture and fisheries, where he was struck by the number of examples of academic papers detailing “really cheap bits of computer equipment to monitor XYZ” in poor parts of the world. “I was always really interested in those papers, and how little, cheap computers really can democratise science and give everyone the chance to do fairly complicated stuff that would have, a few years ago, required thousands of pounds worth of kit.” Having read a paper last year (magpi.cc/canopydynamics) about monitoring a forest canopy, Ed decided he could do something similar, despite being “no expert coder.” A Raspberry Pi Zero, Witty Pi 3 real-time

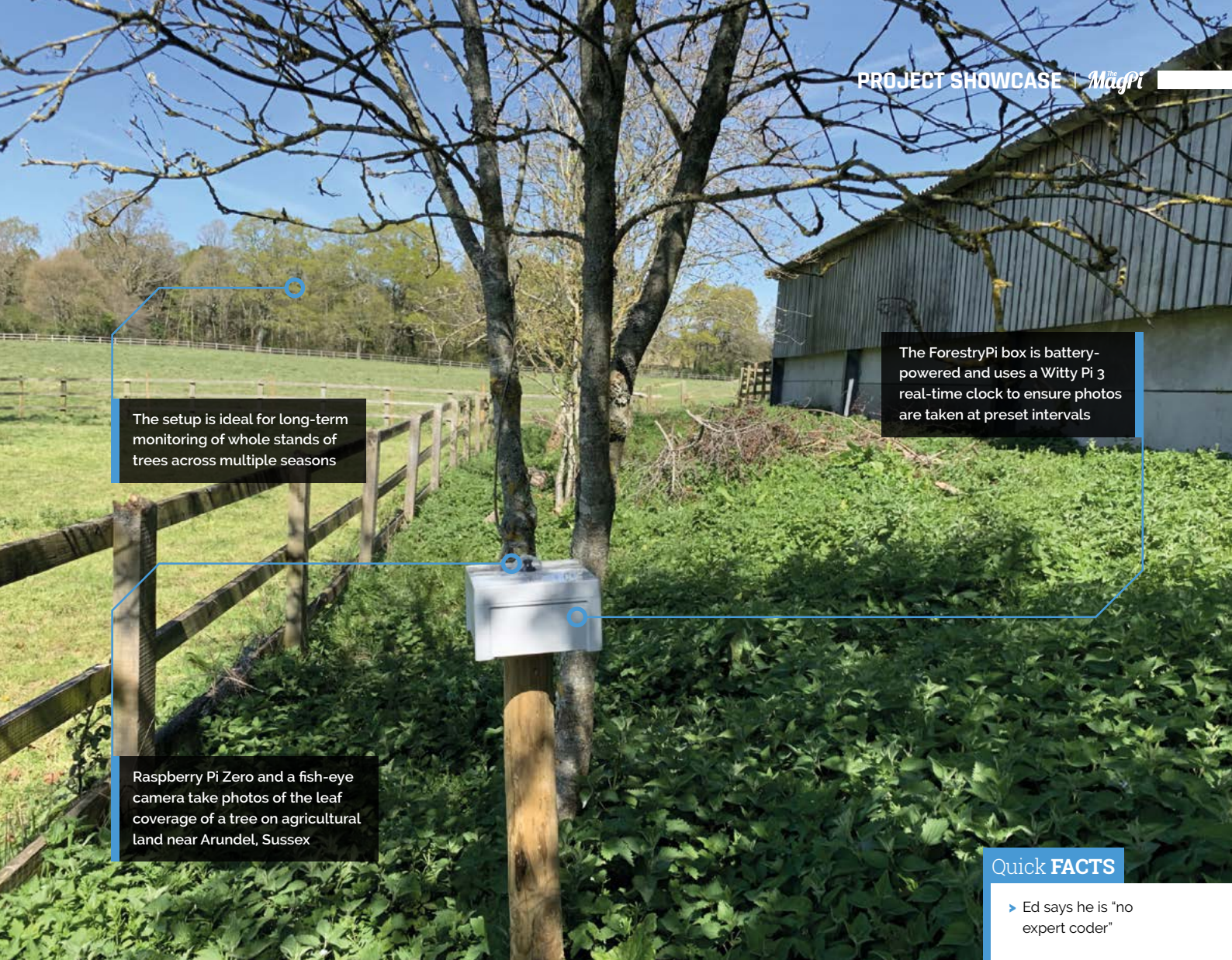

The setup is ideal for long-term monitoring of whole stands of trees across multiple seasons

The ForestryPi box is battery-powered and uses a Witty Pi 3 real-time clock to ensure photos are taken at preset intervals

Raspberry Pi Zero and a fish-eye camera take photos of the leaf coverage of a tree on agricultural land near Arundel, Sussex

Quick FACTS

- ▶ Ed says he is "no expert coder"
- ▶ A friend called his code "just disgusting" – but it works!
- ▶ Ed's pupils will benefit from ForestryPi
- ▶ He's set it up at the primary school where he's based
- ▶ It will become a multi-year citizen science project

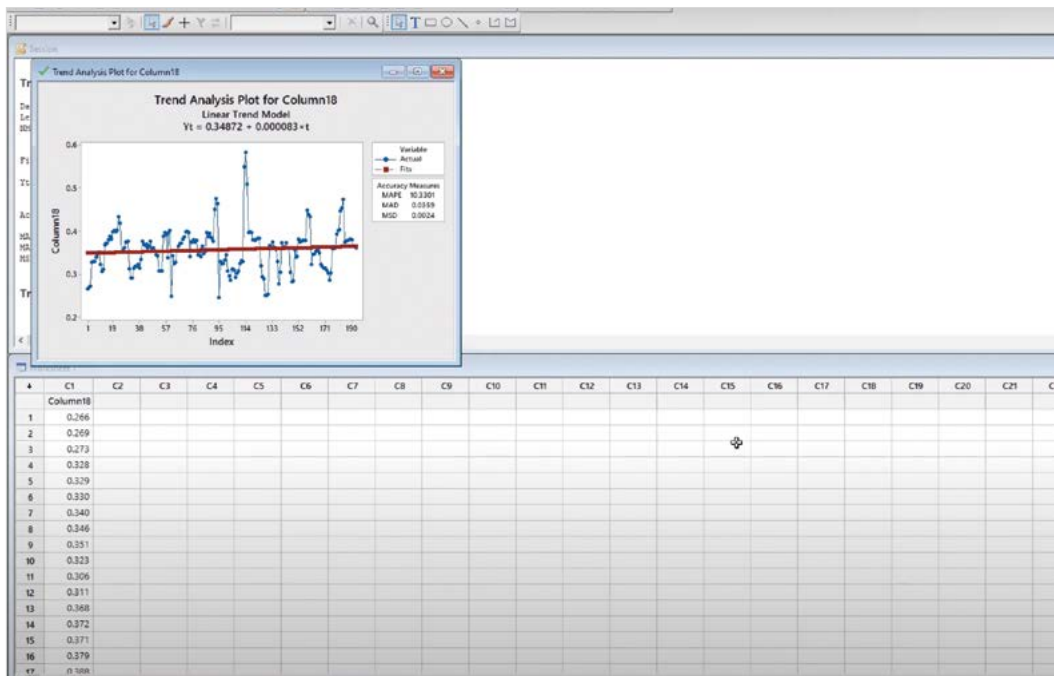

◀ Adding the images to a database helps track leaf coverage over time

Take hemispheric photos



01 ForestryPi is based around a Raspberry Pi Zero with a 32GB SD card, so there is plenty of storage space for the photos it takes over a lengthy period. Find setup code and instructions at magpi.cc/forestcamtut.



02 Attach a fish-eye lens to Raspberry Pi and add cables for a powerful battery pack so the setup can run without user intervention for several months.



03 Attach a Witty Pi 3 real-time clock so the Raspberry Pi knows when to activate the camera shutter. House everything inside a sturdy, weatherproof box and attach securely to a tree trunk, with the camera pointing upwards to capture leaf canopy changes.

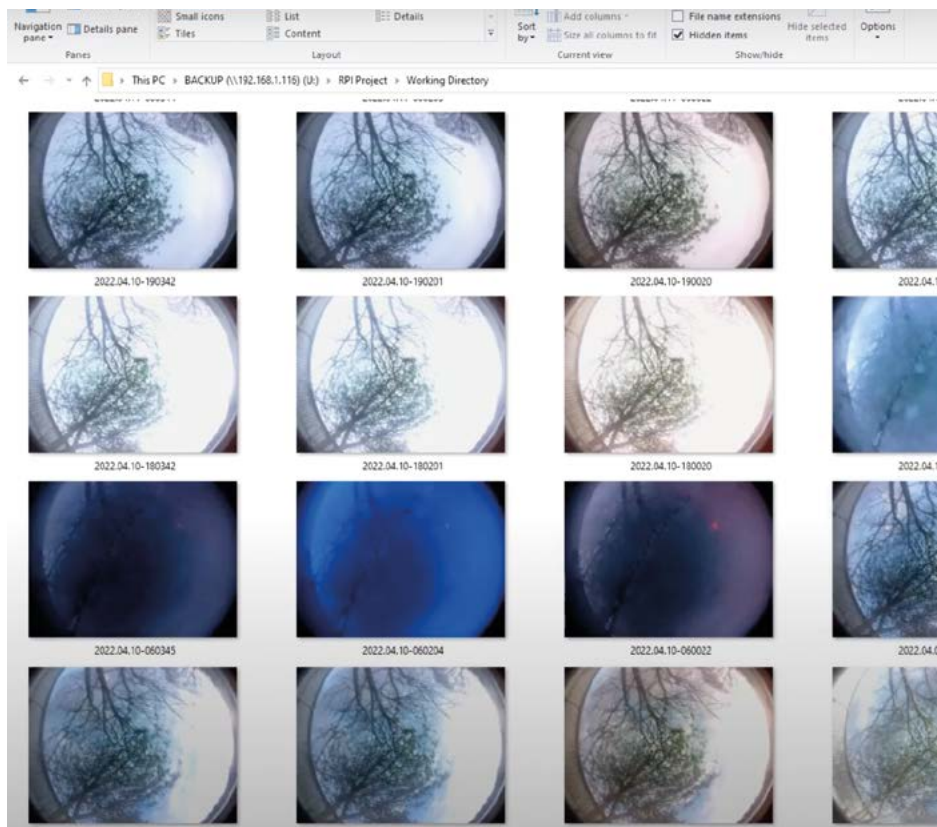

▲ Photos downloaded from ForestryPi's SD card show the variable image quality involved in automated photography

clock, fish-eye lens, 20,000 mAh battery pack, and a 32GB SD card, plus a plastic casing, formed the basis of the ForestryPi setup.

Ed details how he set up ForestryPi on the Green Lane Forestry website (magpi.cc/hemiguide), largely using software such as Microsoft RStudio he had used while studying, along with ImageJ (imagej.net) to process the photos the time-lapse

“His approach of working backwards to get something serviceable nonetheless bore fruit”

camera produced. The camera itself is mounted on the trunk of a tree in a weatherproof box. Keeping the rain out was a big challenge for Ed, who came up with the parts list and built the complete ForestryPi monitoring system himself. A local land agent expressed an interest in the project and they settled on a suitable stand of trees, planning to “generate some data to see the gradual growth and decline of the tree canopy over the course of the growing season and into winter.” A computer scientist friend was “just disgusted” at the code Ed

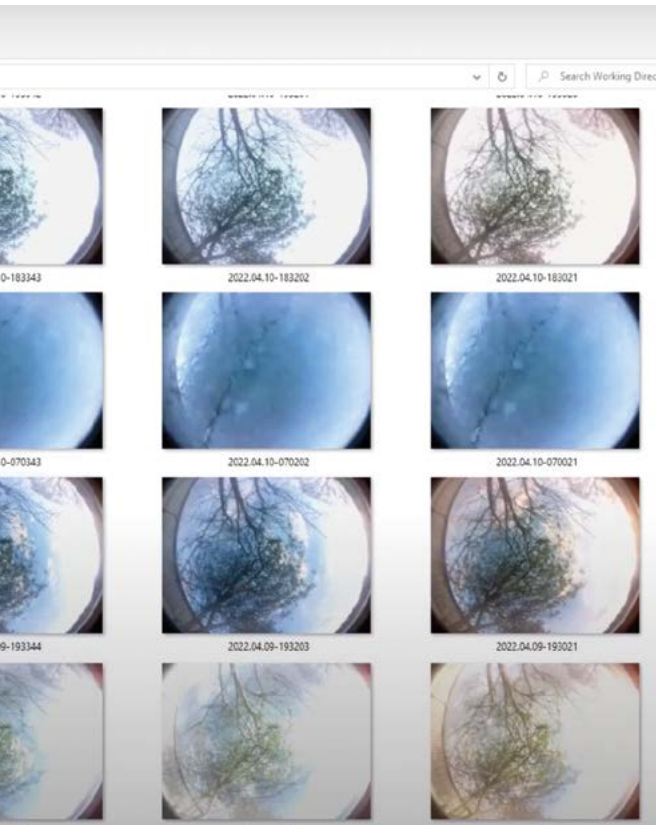

produced, but his approach of working backwards to get something serviceable nonetheless bore fruit.

Rewarding results

ForestryPi is set to take photographs at regular intervals, but the changeable weather conditions in West Sussex, where Ed is based, mean some photos are far more useful than others. Ed says there were “all sorts of problems of light and shadow. I thought it would work fine regardless but, actually, when you come to analyse the image you realise, ‘Nope, that’s too early in the day’.” He also found issues with “weird artifacting” and a lot of scattering of data, along with some interesting results. In fact, Ed sees lots of potential for the setup, especially if a camera can be set up to record the life of a tree or stand of trees over multiple years.

“For the best results, you really do need a woodland where you’ve got cover on all sides,” says Ed. Few people have ready access to a stand of trees whose canopy you can monitor, but lots of people have trees in their gardens. Ed adds that “anyone with an interest in Raspberry Pi is capable of giving this a go and monitoring the growth of their own trees. It’s a fun project, and it provides a good introduction to using Raspberry Pi in a remote setting.” [M](#)

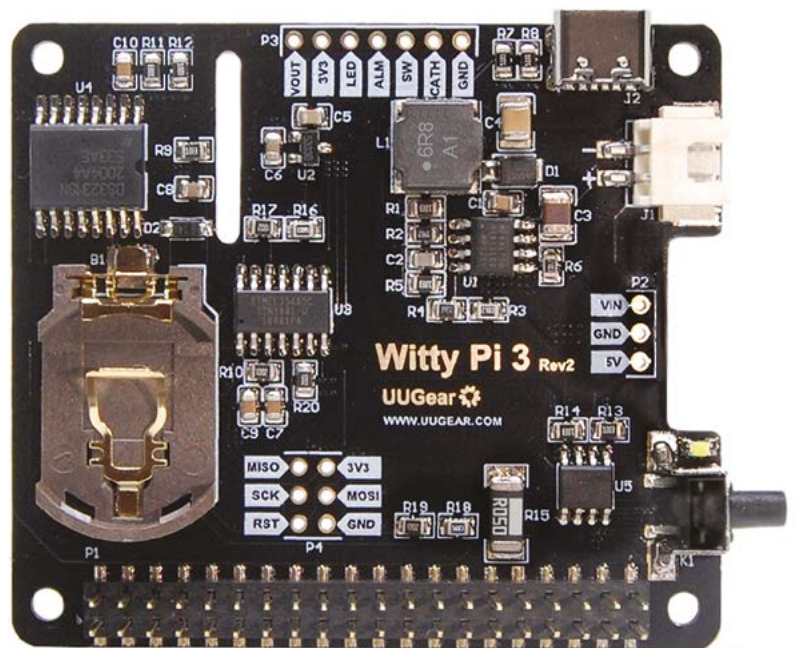

▲ Witty Pi 3 is used to add a real-time clock and power management to the project

HandiPi

When Richard Sutherland wanted to design a case for Raspberry Pi 4, he ended up creating an all-in-one handheld that could double as a desktop computer, as **David Crookes** explains



Richard Sutherland

Richard is a software engineer and hobbyist designer with a passion for astronomy, vintage electronics, and unusual form factor computers.

magpi.cc/handipi

The name of this project is rather inspired because it pretty much encapsulates what it's about. Aside from being a handheld hacking deck making use of Raspberry Pi 4, a touchscreen, and mini-keyboard, HandiPi also comes in, well, handy as an easily portable desktop computer. Not bad given Richard Sutherland originally envisioned creating nothing more than a functional case. "It sort of ran away from there," he smiles.

Richard was inspired by the PiComputer PCB created by Peter 'Bobricius' Misenko. "It's a sort of carrier board for Raspberry Pi Pico that includes a keyboard using 6 mm push-button tactile switches and a display," he explains.

"When I later ordered a Raspberry Pi 4 computer, I got to thinking: what if I could build a case with a screen and a keyboard? I'd still use it with a monitor, keyboard, and trackball at my desk most of the time, but I could take it with me if I wanted to go hack at a friend's house or makerspace."

Snug fit

From the start, Richard knew what he wanted. "The new unit had to be small enough to fit nicely on my workbench, and I wanted it to be battery-powered with some sort of keyboard/screen for use away from the bench," he says.

With this in mind, he picked a 4.3-inch touchscreen roughly the same width as Raspberry Pi 4 and, having had experience creating a portable computer based on Raspberry Pi Zero with a full-size 36-key keyboard and foldable screen, he cracked on designing a similar keyboard.

"The focus was on keeping the size minimal and it meant I did away with the Ethernet and most of the USB ports on Raspberry Pi 4," he adds. "But, while the screen is smaller than is comfortable for long periods of work, the 36-key keyboard works surprisingly well for thumb-typing. There was, however, a bit of a learning curve figuring out the

Embedded within the 3D-printed case is a Raspberry Pi 4 computer connected to a touchscreen and keyboard

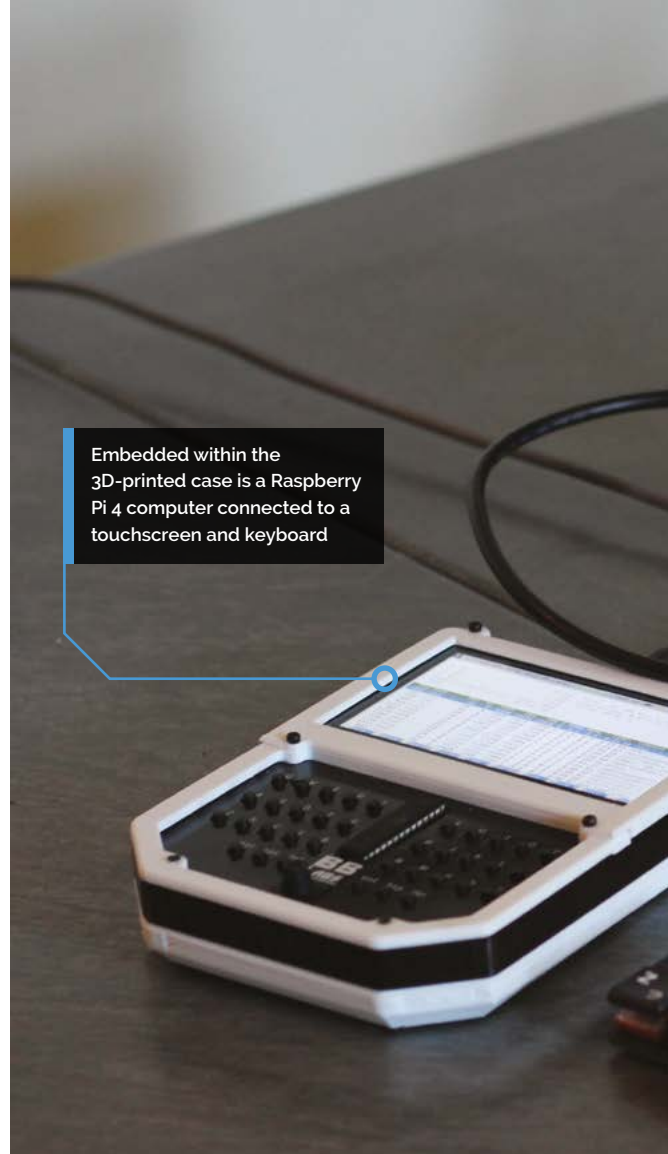

minimum required support circuitry to make the chip function and output USB."

Key to success

The custom 10 × 4 ortho keyboard incorporates a five-way directional button, and it makes use of an ATmega328 DIP IC running a version of QMK firmware. Richard has also made use of a 5000 mAh battery pack which allows HandiPi to be used as a portable for up to four hours.

"I chose the PiSugar module for battery management because it was designed to mount under Raspberry Pi and connect to the GPIO header via pogo-pins, rather than on top as with most HATs. This let me wedge it between [Raspberry] Pi and the display, only adding a couple of millimetres to the overall design."

With hindsight, he'd have retained the Ethernet and double-stack USB ports. "After the work to remove them was done, I'm convinced it wasn't worth it – using a modified Raspberry Pi 4 turned out to be just something like five millimetres thicker. I built a cutout for the Ethernet jack so it sits flush with the case bottom. Having the USB 3.0 ports would be nice and the Ethernet port could potentially come in handy."



A single-height USB port replaces the original double-stack USB port on Raspberry Pi 4. As such, the keyboard is attached to Raspberry Pi using wires and this saves a few millimetres of thickness

The HandiPi has been designed so that it can be connected to an external monitor and keyboard and used like a desktop computer

Quick FACTS

- ▶ It's a portable/deskop hybrid computer
- ▶ Richard designed it using Fusion 360
- ▶ He also created his own PCB
- ▶ Size was kept to a minimum
- ▶ It's being used as a terminal for light coding

Still, with a cool 3D-printed case and an original Game Boy-like styling, the overall project is

“ I could take it with me if I wanted to go hack at a friend's house or makerspace ”

immensely impressive. “For the primary use – powering my workbench computing – it’s perfect,” he says. “The second, smaller screen on the unit itself can come in handy to show little bits of info from a distance, and I’ve found it can be pretty handy to ‘borrow’ the USB-C power sometimes. The reaction has also been pretty positive and, overall, I’m definitely pleased with how it turned out.”



▲ The HandiPi is small enough to fit on an adult's palm. Richard says: “It works well enough to handle a few lines of code here and there and definitely suffices for web browsing”

The Lost Sounds Project

A noticeable reduction in birdsong led a digital technologist to set up a Raspberry Pi-based nature-watching project for schoolchildren, learns **Rosie Hattersley**



Dr Liz Edwards

Liz is a interdisciplinary researcher working in the Future Places Centre at Lancaster University, where she uses digital technologies and code in applied projects.

thelostsounds.org

Identifying creatures based on their appearance is a matter for the observant, with a little help from reference books, related websites and apps, and maybe some clever AI.

Sound identification requires a different set of tools, and is reliant on the bird or animal in question first having been recorded and positively identified so that subsequent naturalists may be sure of what they're hearing. The Lost Sounds Project puts this recording process in the hands of schoolchildren who explore their local environment and use Raspberry Pi computers and microphones to record bird songs, as well as their unique characteristics.

Mixed media

The Lost Sounds Project was piloted in Morecambe Bay, "one of the most significant sites in the UK for breeding birds," explains Dr Liz Edwards, part of the Ensemble team at Lancaster University's School of Computing & Communications. Liz, herself, has a PhD in digital technologies to interpret public gardens, and experience both as a geography teacher and in multimedia design. "I'm not a computer scientist, but I use digital technologies and code in applied projects to do with nature connection and environmental science," she says.

Inspired by Scott Garner's wonderful 'Beet Box' (magpi.cc/beetbox), Liz went on to create the equally out there Rhubaphone, which invited



visitors to Clumber Park gardens to pick up various cultivars and listen to details of their differences and quirks (see magpi.cc/talkingrhubarb). Both such projects, of course, use Raspberry Pi.

Lost Sounds, meanwhile, takes its name and inspiration from "the power of *The Lost Words* book by Robert Macfarlane and Jackie Morris, and by several conversations noting the changing soundscape of the area, including the loss of corncrakes and the decline of curlew." The nature study project is often run as a cross-curricular activity in primary schools (for which Liz has

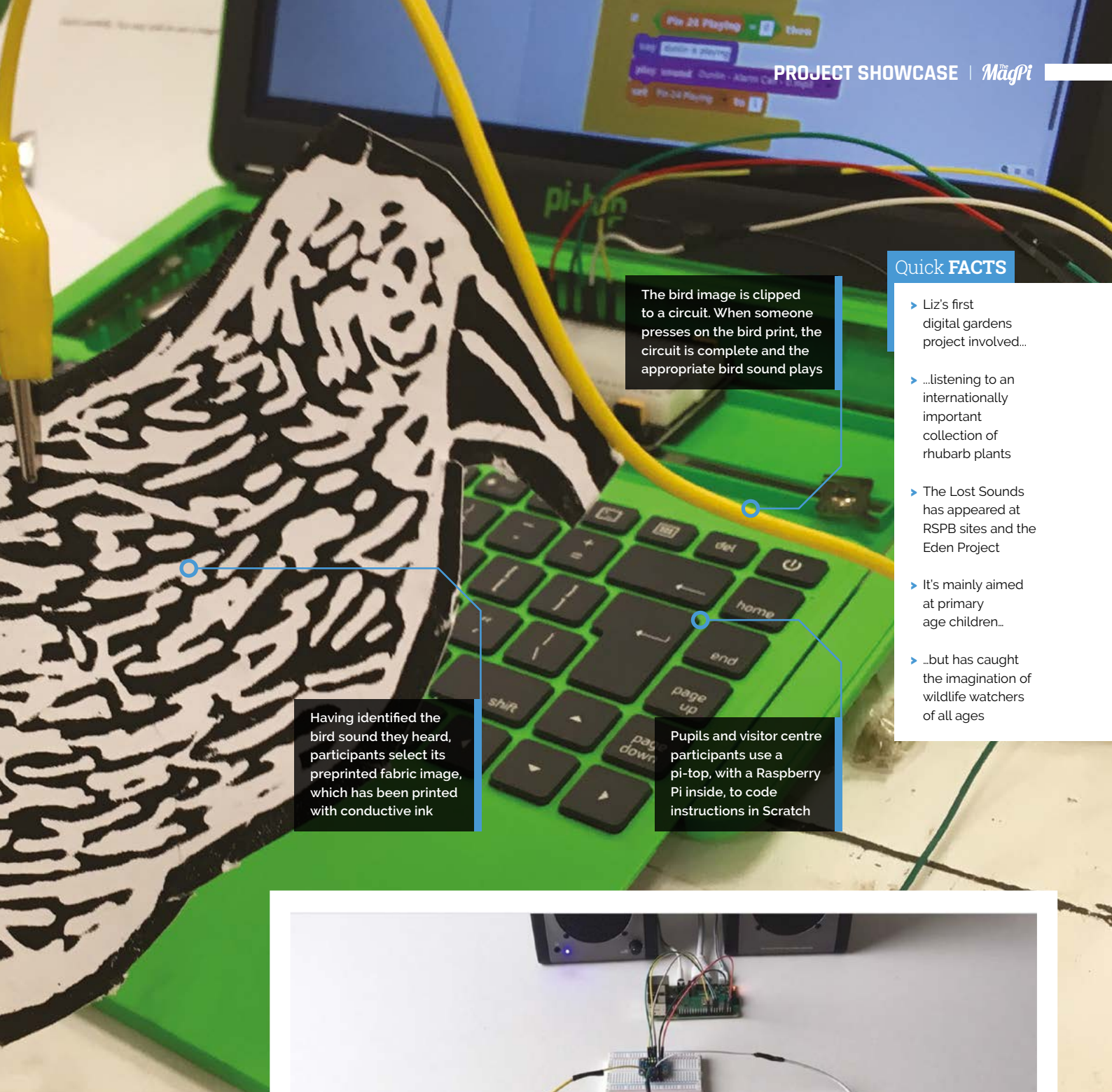

The bird image is clipped to a circuit. When someone presses on the bird print, the circuit is complete and the appropriate bird sound plays

Having identified the bird sound they heard, participants select its preprinted fabric image, which has been printed with conductive ink

Pupils and visitor centre participants use a pi-top, with a Raspberry Pi inside, to code instructions in Scratch

Quick FACTS

- ▶ Liz's first digital gardens project involved...
- ▶ ...listening to an internationally important collection of rhubarb plants
- ▶ The Lost Sounds has appeared at RSPB sites and the Eden Project
- ▶ It's mainly aimed at primary age children...
- ▶ ...but has caught the imagination of wildlife watchers of all ages

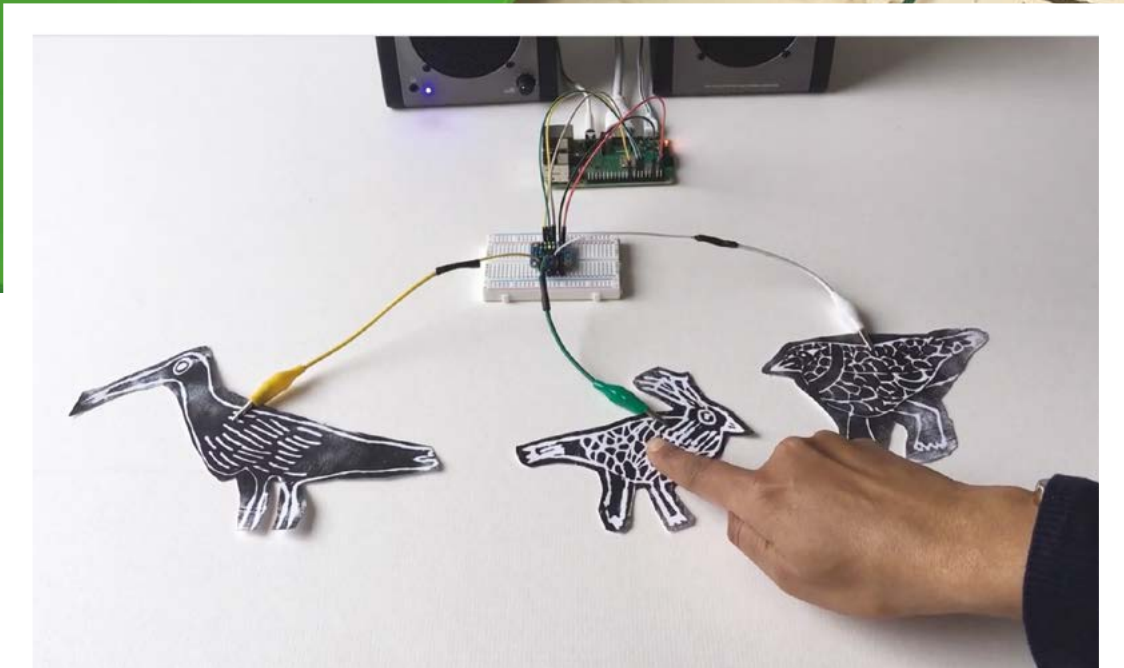

▶ Pressing down on the fabric bird print creates a circuit and makes the birdsong play

▶ An interactive soundscape of Morecambe Bay created by pupils at West End Primary School in Morecambe

▼ Raspberry Pi 3 is used to create bird sounds



put together resources and runs teacher training sessions), but you might also spot it at beacon sites such as RSPB nature reserves, the Eden Project, and so on.

Noticing and responding to the local environment is the common thread. Liz lists birdwatching, listening to bird calls with directional microphones, making conductive ink prints, learning to ‘sing’ bird calls, looking at sonogram shapes of bird calls, and creating interactive displays to share with school or community groups. The more tech-focused activities involve making a circuit with a capacitance sensor, then writing code in Scratch so that the correct bird’s call plays when the corresponding image primed with capacitive ink is touched. An example of this can be seen on Vimeo ([magpi.cc/birdcallprints](https://vimeo.com/magpi/birdcallprints)).

The sounds are recorded locally, but can also be cross-referenced against an open-source bird song directory such as xeno-canto (xeno-canto.org).

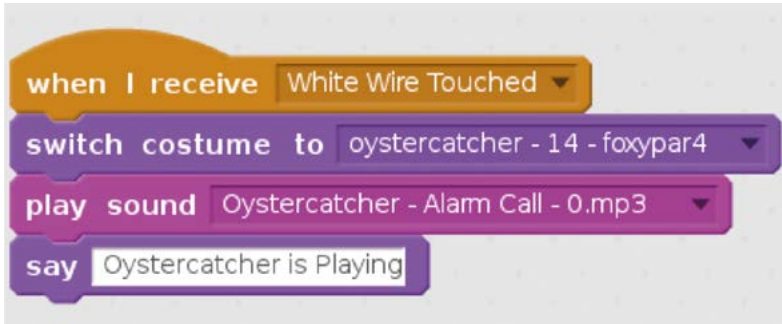

Feathered friends

Liz came to use Raspberry Pi for The Lost Sounds having tried several technologies and coding environments while prototyping the project. “My colleague (and friend of *The MagPi*) Lorraine Underwood was incredibly helpful in this initial development stage,” says Liz. Raspberry Pi had several standout features: “the ability to store substantial image and audio files, the ability to run Scratch, and incorporate circuit making.”

Pi-tops became part of the mix when Liz realised it was far more straightforward to provide a consistent set of computing kit than deal with

Working in pairs or threes, children use Scratch code to instruct when each sound should play

“Noticing and responding to the local environment is the common thread”

different IT setups at schools with whom she was collaborating. She also uses Bare Conductive Touch Boards for the large interactive soundscape installations that are left in the venue after the workshop. “It is an easy system for external people to manage independently,” she reasons. [M](#)

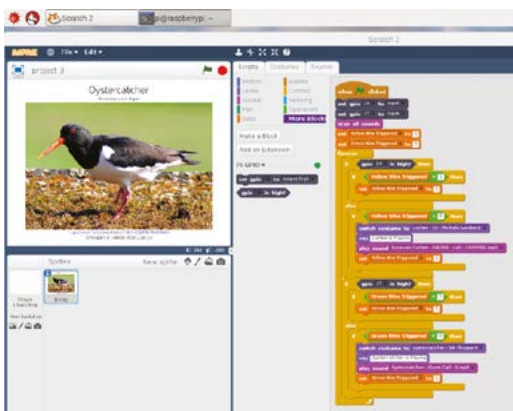

Children follow Scratch code instructions to play the correct bird sound when they spot it

Interactive birdsong

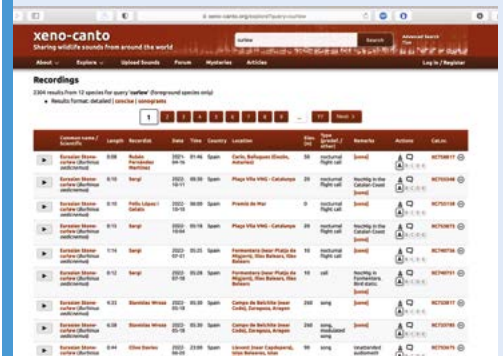

01 Record and identify bird sounds in your area using a directional microphone, checking the species against a database such as xeno-canto.org. Print images of the birds identified. Liz recommends printing with conductive ink, if available.

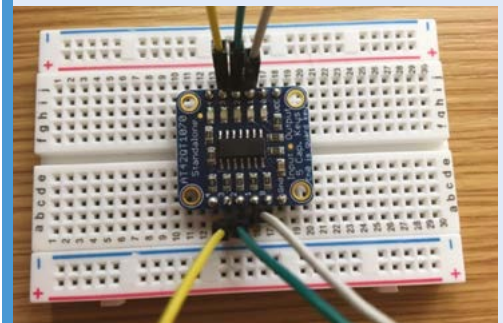

02 Create a simple circuit with a capacitive sensor connected to a Raspberry Pi. If you used conductive ink for your bird print, you can add it to the circuit using a crocodile clip. Other connection options are possible if you didn't use such ink.



03 Use Scratch to create code to display a photo of each bird species and play its song when the circuit is complete.

Automatic Fish Feeder Deluxe

Aquarium ownership just got a little easier thanks to this fantastic Wi-Fi-connected, Pico W-driven make. **Nicola King** investigates first-rate fish feedings



Erik Berglund

Sweden-based Erik works with AI and enjoys dabbling in home automation. He has lost track of how many Raspberry Pi boards he has in his home.

magpi.cc/erikberglundyt

Like many aquarists, Erik Berglund and his family face the issue of what to do with their pet fish when they want to leave the family home for any length of time. So, like any good maker, Erik came up with his own solution.

“To give my family the freedom to still go on long vacations without having to worry about finding a fish-sitter, I decided to make an automatic fish feeder,” he tells us, having recently purchased an aquarium for his young daughter. “There were many nice designs available online, but they were all missing something – control and reliability. I wanted a solution that could be easily controlled from a smartphone, with a minimum of hassle.”

Erik also specifically wanted reliability in terms of timing, so that any power outages wouldn’t interrupt his fishes’ feeding schedule.

Practically perfect Pico W

Working on his idea when he could, Erik says a lot of his time was spent on designing and 3D-printing the plastic parts, which saw several iterations. The feeder itself is controlled by an Android app he developed himself (magpi.cc/fishfeederapp). “It is a very simple app; I wanted it to be as intuitive as possible. There is no need to connect manually to the feeder: the app senses the feeder automatically as long as [they] are both on the same Wi-Fi network,” Erik explains. “This is done using UDP multicasting, which is really nice for zero-conf connections. The schedule is stored in the feeder, not the phone, so you can use multiple phones to control the feeder and the feeder works without the phone present.”

When he started the project, Erik wanted a microcontroller that was powerful, well-documented, low-cost, MicroPython-friendly, and Wi-Fi-capable. Pico W fitted perfectly with Erik’s concept, which involves using a 3D-printed auger to measure out small amounts of fish food at predetermined times each day.

“The auger is driven by a common RC servo and is controlled by the Pico W, which acts as the brains of the device,” he explains. “Pico W coordinates everything: it receives schedule updates from the app, connects to NTP servers online to get the correct time, stores the correct time in the real-time clock (RTC), controls the servo, and keeps track of the feeding schedule.

“At the beginning of each minute, Pico W loads the schedule from the RTC module’s permanent storage, checks if it is time for a feeding and, if yes, turns on the servo for the required amount of time,” he clarifies.

Once every hour, Pico W compares the current time from the NTP server to the time stored in the RTC, to see if it needs adjusting. See the feeder in action here: magpi.cc/fishfeeder.

Manageable make

Erik doesn’t think his project would be too difficult for someone to replicate. If you want to attempt your own version, he has very generously shared comprehensive instructions, including 3D-printing files on Thingiverse (magpi.cc/fishfeederstl) and a link to his GitHub firmware.

“I’m working on an adapter that will couple the feeder to the aquarium without letting dust in. If anyone finds a bug or has a feature request, I will of

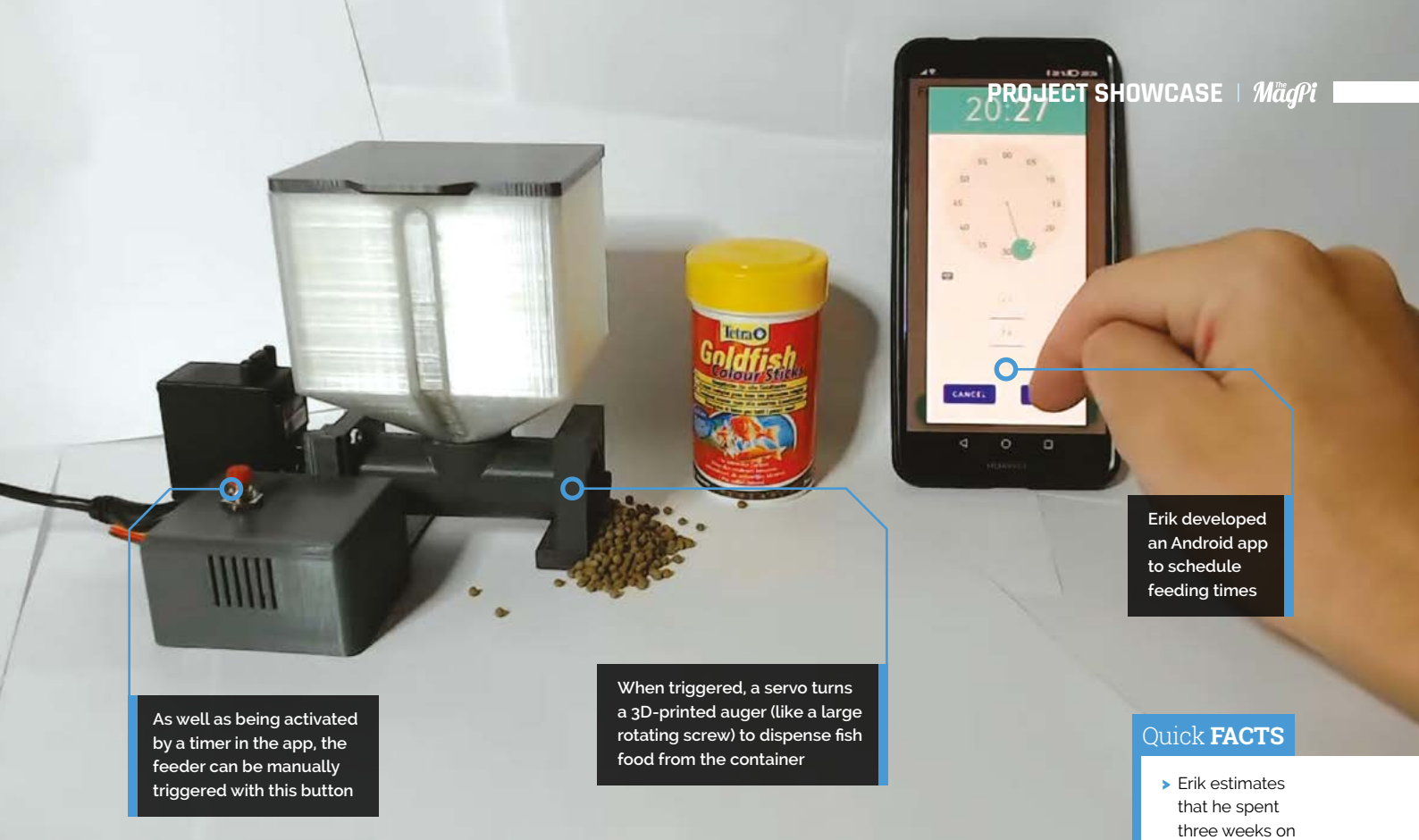

As well as being activated by a timer in the app, the feeder can be manually triggered with this button

When triggered, a servo turns a 3D-printed auger (like a large rotating screw) to dispense fish food from the container

Erik developed an Android app to schedule feeding times

Quick FACTS

- ▶ Erik estimates that he spent three weeks on the project; it cost around €30
- ▶ The hardware consists of a Pico W, RTC with battery, push-button, and servo
- ▶ One of Pico W's cores handles the network; the other deals with the RTC and servo
- ▶ The app allows the user to program up to 18 feedings of granulated food per day
- ▶ Erik is now considering making a self-balancing robot with his son

course do my best to fix that as well," he affirms. So, have the fish enjoyed their food yet from this clever device? "Not yet," says Erik. "My daughter's

“ I wanted a solution that could be easily controlled from a smartphone, with a minimum of hassle ”

aquarium is in the startup phase and there are only two small fish in there, which is too few for even the smallest amount the feeder can dispense. Once the population grows to about ten, I will give it a try.” But, the most important thing is that Erik's six-year-old daughter is thrilled with her fish feeder! [📖](#)

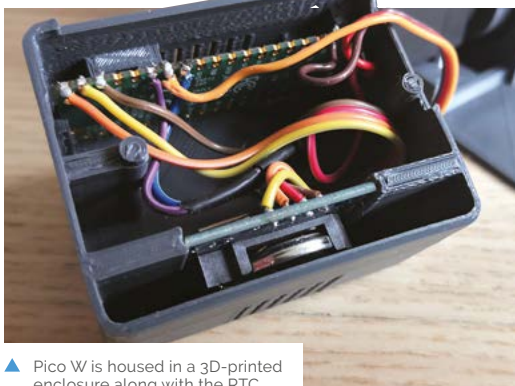

▲ Pico W is housed in a 3D-printed enclosure along with the RTC

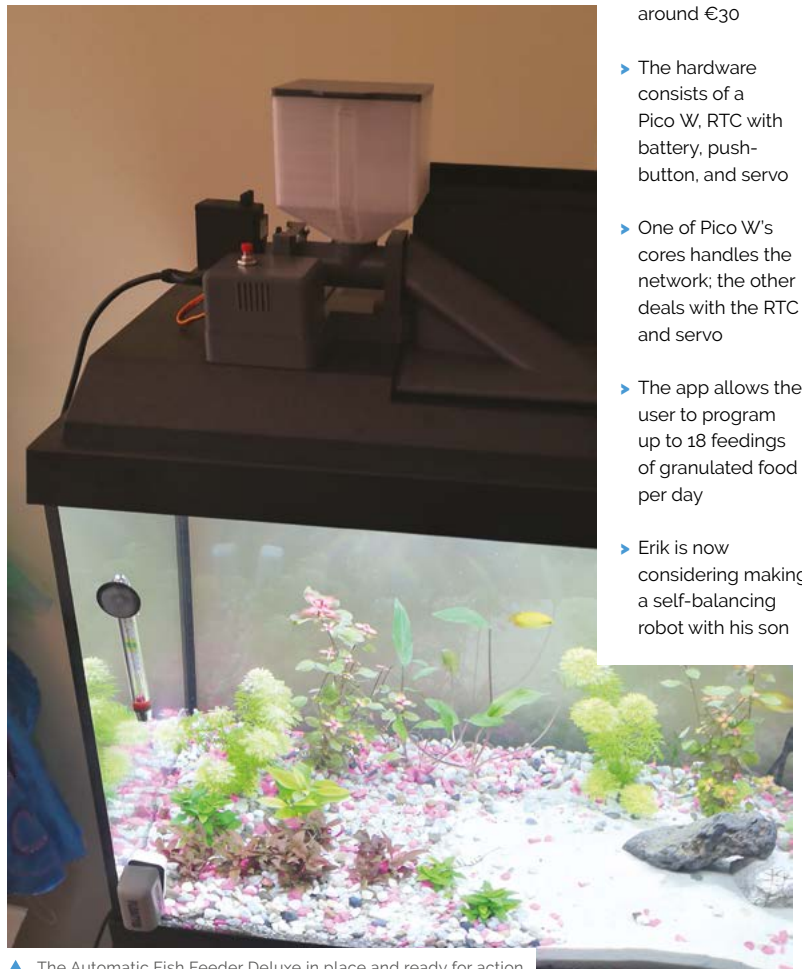

▲ The Automatic Fish Feeder Deluxe in place and ready for action

CNC Drawing Machine

Ever considered making your own CNC machine?

Nicola King speaks with a smart young maker who has done just that



MAKER Yannik Dolde

A mechatronics engineer student, Yannik started playing with an Arduino at the age of 14, undertaking several small projects combining electronics with his own developed programs.

magpi.cc/instpheux



Warning! Electrical Safety

Please be careful when working with electrical projects around the home. Especially if they involve mains electricity.

magpi.cc/electricalsafety

A long-held ambition to create his own CNC machine drove 19-year-old Yannik Dolde towards his goal and the result is a pretty amazing drawing device, which he's made largely from upcycled parts that he had lying around.

As if that level of ingenuity were not enough, he's also developed his own software to ensure it does exactly what he wants it to.

The whole package

"This small CNC drawing machine, which is more or less a pen plotter, is just developed for testing the software and hardware for future projects," Yannik tells us. This resourceful maker upcycled some old CD drives and floppy drives for the X and Y axes, as "using them was the easiest way to get a linear movement system with already installed motors."

The pen is mounted into the inner 3D-printed section of the machine with a screw. "This part is shaped like a cross," says Yannik. "The outer part has the negative shape so that it can only move up and down." A servo controls the height of the pen and can be set with G-code.

After failing to find any software to satisfy his requirements, Yannik ended up developing his own, called CNZero, which he says is still very much a work in progress. "Basic functionalities are already given, but there is so much more I can and plan to do with this. I want to extend it to a proper and easy-to-use CNC software." Developing the software is clearly challenging, "but I like going forward step by step, and I am enthusiastic about developing it further."

Super subsystems

Getting down to the nuts and bolts, the CNC drawing machine is split into three subsystems. Firstly, a Raspberry Pi 3B+ provides the user interface, data manager, and process controller. Secondly, Yannik has used an Arduino Mega with a G-code interpreter to control the motors. Thirdly, GPIO_lib, some software he developed

previously, allows him to control the Arduino with a Python script.

To use the machine, Yannik engages the motors and sets the axis to the zero position. He then selects a G-code file (a standard way of controlling CNC machines) and starts the sending process. Raspberry Pi reads it line by line and sends the commands to the Arduino Mega. "The G-code itself is translated into coordinates on the X, Y, and Z axes, which set the movements for the motors. After the movement is finished, the Arduino sends a return flag back to send the next line of G-code," describes Yannik. His flowchart (Figure 1) clearly outlines the process.

“This small CNC drawing machine is developed for testing the software and hardware for future projects **”**

With his code not yet on GitHub, as he is still perfecting and amending it, Yannik is planning "on building a small real CNC machine running with CNZero," and he's definitely been buoyed along by the very positive feedback so far received. "I get a lot of feedback and help in the community, so I want to give something back, help others, and share my knowledge. Things like this are one of many reasons why I love programming."

Yannik used Raspberry Pi because it runs Linux which makes file management "super-simple", and, along with the capability of running Python code, the price, size, and low power cost, he describes it as "the perfect choice." Along with his father, he is also interested in undertaking some home automation projects: "There are a lot of further ideas and projects in my mind where a Raspberry Pi is a central component." **M**

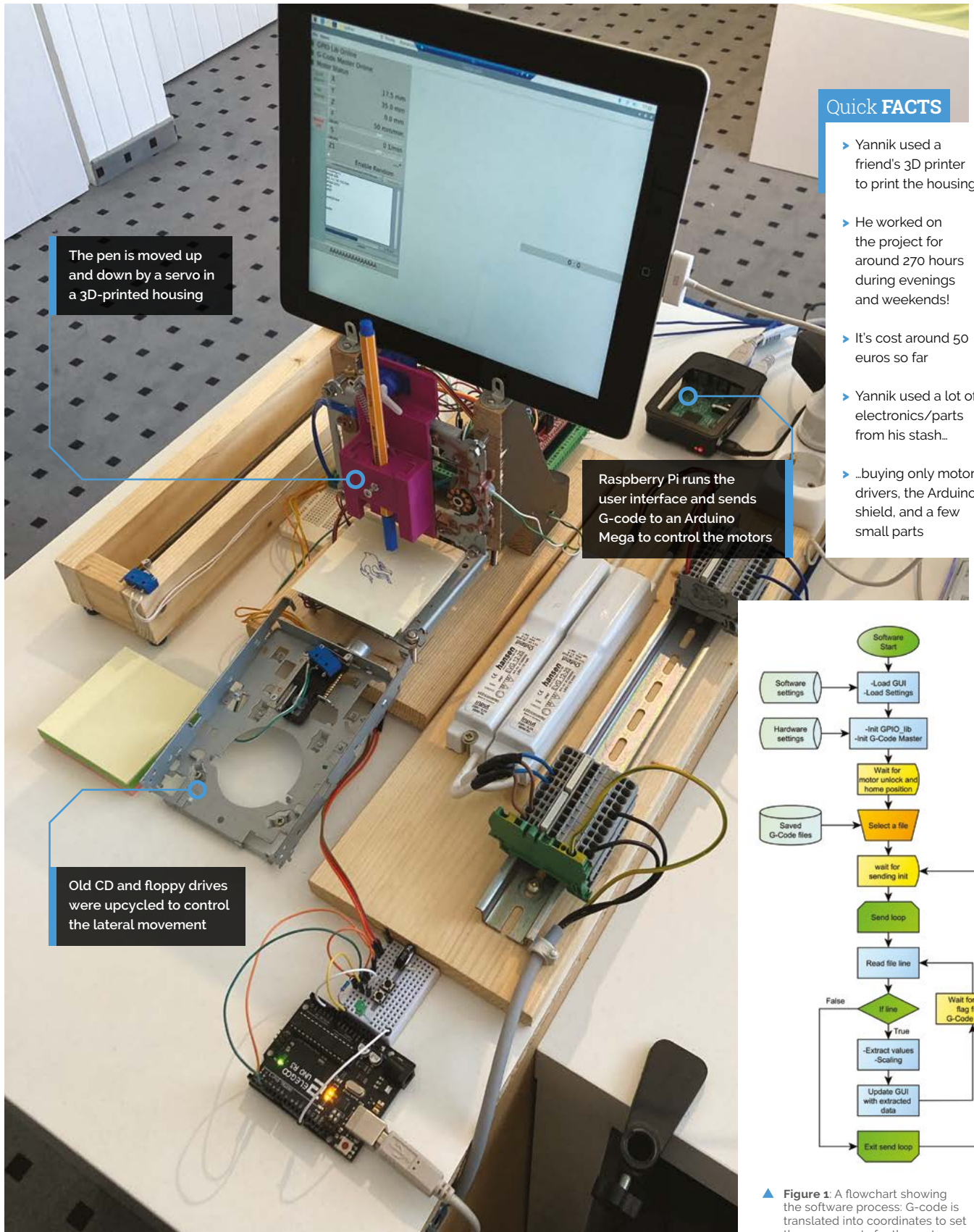

Quick FACTS

- ▶ Yannik used a friend's 3D printer to print the housing
- ▶ He worked on the project for around 270 hours during evenings and weekends!
- ▶ It's cost around 50 euros so far
- ▶ Yannik used a lot of electronics/parts from his stash...
- ▶ ...buying only motor drivers, the Arduino shield, and a few small parts

The pen is moved up and down by a servo in a 3D-printed housing

Raspberry Pi runs the user interface and sends G-code to an Arduino Mega to control the motors

Old CD and floppy drives were upcycled to control the lateral movement

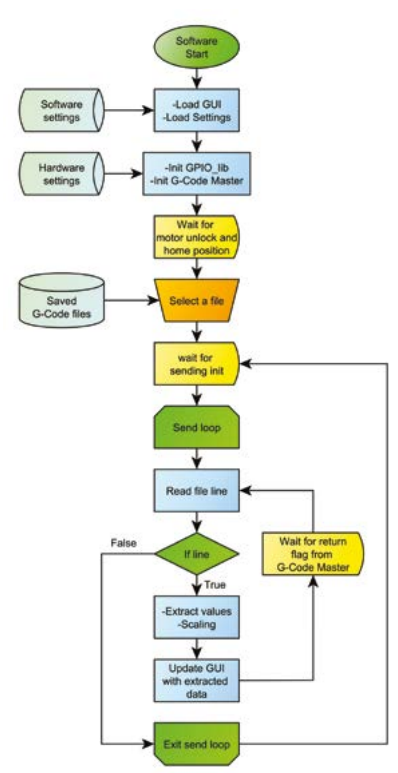

▲ **Figure 1:** A flowchart showing the software process: G-code is translated into coordinates to set the movements for the motors

JägerMachine

This automated shot dispenser can be activated via email.

Rob Zwetsloot sends a few messages for research pour-poses



Pegor Karoglanian

Embedded software engineer during the day, and maker in his free time. He builds projects for fun or to learn something new.

magpi.cc/jagermachine

The Internet of Things (IoT) is a bit of a nebulous, poorly defined concept that really just means you can control objects wirelessly. One use of IoT tends to always be cool though, and that's drink or food prep – probably in no small part due to *Star Trek's* replicators. While we've seen a few drinks dispensers made out of Raspberry Pi, we always love to see a new one, especially when it involves a couple of Jägerbombs. This is the JägerMachine.

"It started out as a gift for one of my friends and kept getting more and more complicated," creator Pegor Karoglanian tells us. "It's essentially a machine that pours a shot of Jägermeister or any beverage of choice. The cool part about it is that, once it is connected to a Wi-Fi connection, I can send it an email and it'll pour a shot and display the message I sent."

Autobar

Pegor's goal with the project was to have a device that felt like a commercial product, and was overall easy to use as well.

"That meant creating a user interface that allowed for all the important bits to be configured without having to SSH or change files directly on the SD card," Pegor explains. "The Raspberry Pi is running in Kiosk Mode, with Chromium used to display a web page that is hosted by Raspberry Pi itself. This is what is displayed on the touchscreen display and can be used by the user to configure the machine, pour a shot themselves, or check the last message they received."

The machine itself uses 3D-printed parts from a traditional FDM printer and a resin printer, the latter of which being Pegor's own printer.

"I outsourced the main body to some company and printed all the smaller stuff with

the resin printer," Pegor says. "The smaller parts included the enclosure which the shot glass sat in, a board that housed the Hall effect sensor, and also little parts to hold the pump and fan. Since I had a few peripherals (level shifter, pump, motor drive, Hall effect sensor, LED ring) and didn't want a ton of wires everywhere, I also designed a custom PCB to more easily connect all the peripherals together."

“ The cool part about it is that, once it is connected to a Wi-Fi connection, I can send it an email and it'll pour a shot and display the message I sent ”

A wooden veneer was glued onto the side of the machine, which Pegor was very impressed with. When a drink is queued up in the system, the Hall effect sensor will be monitored to see when a shot glass with a magnet on its base is placed on the platform, so it knows it's safe to then pour.

Drink Meister

Pegor has been using the machine for a few weeks now and says it works great: "[I've] poured myself the occasional shot. The bad part is that Jägermeister can get pretty sticky and the pouring does cause a little bit of splashage."

He hopes other people will give it a go, so all the source code and design files are available on his GitHub: magpi.cc/jagermachine. 

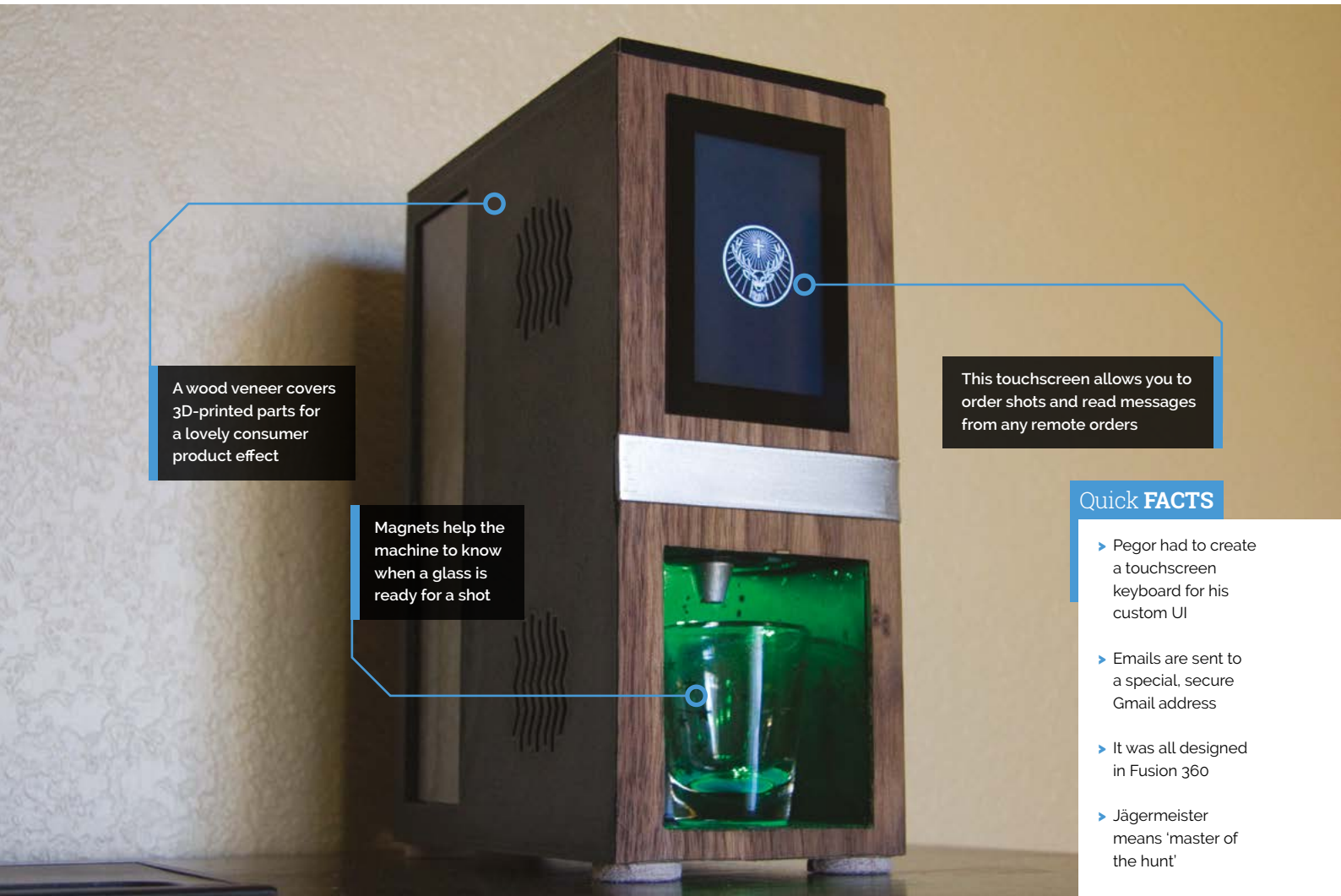

A wood veneer covers 3D-printed parts for a lovely consumer product effect

Magnets help the machine to know when a glass is ready for a shot

This touchscreen allows you to order shots and read messages from any remote orders

Quick FACTS

- ▶ Pegor had to create a touchscreen keyboard for his custom UI
- ▶ Emails are sent to a special, secure Gmail address
- ▶ It was all designed in Fusion 360
- ▶ Jägermeister means 'master of the hunt'
- ▶ It's open-source under the MIT licence



▲ There is some splashing, but Pegor believes a longer nozzle will fix this



◀ Raspberry Pi powers the various pumps and sensors, and also connects to a custom PCB for the project

Open Book Abridged Edition

Read all about it! Joey Castillo has updated his Open Book project and it now makes full use of Raspberry Pi Pico, as **David Crookes** explains



Joey Castillo

Joey Castillo is a software and hardware engineer, as well as purveyor of Oddly Specific Objects. He's engineered products from circuit board to product launch, with everything from firmware and UX to manufacturing and marketing in between.

magpi.cc/openbook

Once upon a time – about three years ago, in fact – Joey Castillo went up against established e-book devices such as Amazon’s Kindle by creating a DIY, open-source equivalent. Called the Open Book, it was a Microchip SAM D51-powered Feather board that sought to free users from the limitations of having to grab e-books from proprietary stores. It also aimed to demystify electronics.

Since then, Joey has revised his project, ditching the SAM D51 microcontroller in favour of Raspberry Pi Pico’s RP2040 dual-core microcontroller. In doing so, he drastically slashed the number of components from 114, and redesigned the custom-printed circuit board. The result is the Open Book Abridged Edition, and anyone with a soldering iron can build it for themselves.

“I want folks to understand that the gadgets surrounding them aren’t magic,” Joey says

Basic book

The idea for Open Book began in 2018. “The origin is in Unicode – specifically GNU Unifont which is an open-source bitmap font with support for

all the languages of the world,” Joey explains. “When I discovered it, I was ensorcelled by the idea of a simple gadget that could display text in any language. After brainstorming ideas for things like a pocket communicator or a journal, it hit me: it’s a book!”

At first, Joey had trouble making the project solderable by hand using basic tools. Yet, using a Raspberry Pi Pico microcontroller board brought simplicity. “All these parts are now consolidated on a single castellated module,” Joey says. What’s

“I want folks to understand that the gadgets surrounding them aren't magic”

more, the whole thing runs using a couple of AAA batteries. “Folks can easily go out to their nearest grocery store and buy them,” he notes. “Shipping LiPo batteries is also complicated.”

Simple text

By packing the back of the PCB with documentation, Joey is able to explain how the microcontroller, controls, external flash, power, and display are attached and work as users put it together. Once done, they can then get to grips with the software – something else which has been revised.

“I’ve built a new view- and event-based GUI framework called Focus that’s running the show,” Joey says. “Right now the software supports displaying a list of books and selecting one, as well as a reading experience with a progress bar and



▶ The Open Book makes use of a relatively inexpensive 4.2-inch greyscale, e-ink panel

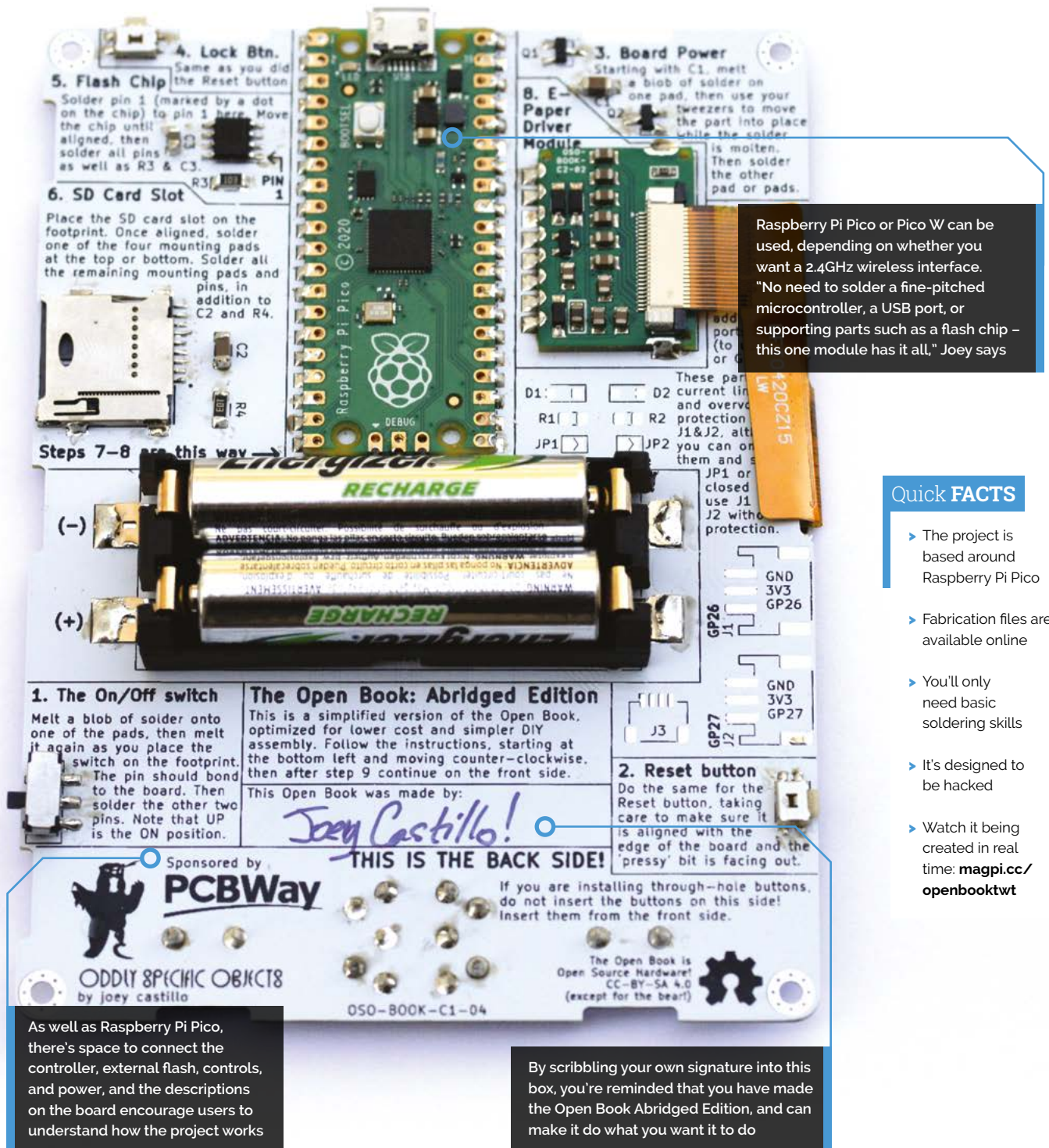

number pages, and a 'quick scrubber' modal that lets you skip ten pages backward and forwards."

Books are viewed in plain UTF-8 text ("the canonical format for books," he suggests) with chapters separated by the ASCII Record Separator 01E. Basic bold and italic formatting use the ASCII Shift Out/Shift In characters. "In the end, it's just plain old .txt with UTF-8 encoding – the one file

format I trust to still be readable in 100 years," he says. And yet it works!

"I re-read *The Great Gatsby* on the old firmware last year, and I've been testing the new firmware by reading a 700-page space opera," Joey tells us. "So far, the gadget has been able to get out of my way and let me get lost in the work. And that's all I could ask of it." 

Open-Source Gamma Spectrometer

Another step in accessible science, this cheap and open-source gamma ray detector can also determine the material it comes from. **Rob Zwetsloot** avoids hulking out

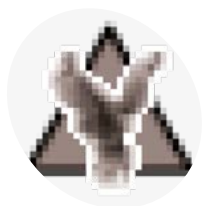

Matthias Rosezky

A Physical Energy and Measurement Engineering masters student at TU Wien. Over the years he's had a deep dive into electronics and can now design circuits and PCBs.

magpi.cc/opengamma

Radiation detection is not something we often have to consider here at *The MagPi* – we're not sure if that makes us lucky or boring – but the equipment is fascinating nonetheless. It's also quite expensive. This is where, once again, Raspberry Pi Pico comes in to help reduce the cost and ease of access of this important kit, with thanks to Matthias Rosezky as well.

"This is a cheap, complete, and open-source gamma spectrometer that you can build for yourself and use without having to worry about expensive equipment or any hardware design," Matthias tells us. "With it, you can easily detect even low levels of gamma radiation, and run spectrometry to determine the composition of a radioactive material. It's highly modifiable, both in hardware and in software, due to different variable on-board parameters and custom pin headers."

It uses a mixture of Arduino code and Pico hardware, with processing done entirely on Pico itself. It makes use of a silicon photomultiplier (SiPM) and scintillator crystal which interact with the detector board to manage this, whereas other solutions need USB sound cards and up to a kilovolt of power. This only needs 30 V.

Microcontroller for the job

"I tried many different microcontrollers before the Pico was released, but availability and cost were always a concern for me," Matthias says, as he explains to us why he chose Pico. "That's because a standard Arduino Uno isn't nearly fast enough for the job and most of the other SAMD microcontrollers, for example, mostly lack excellent software support for the Arduino IDE. When Pico came out, I was amazed by the low cost and, at the same time, great performance and modifiability.

You can do so many things with it, and the software support is great thanks to the Pico SDK and the awesome Arduino-Pico library. And last, but not least, you can get it almost everywhere [cheaply], even in the current state of the industry!"

With a microcontroller selected, Matthias started creating separate modules for his device and assembled them on a breadboard before designing PCBs for the final product.

"Loads of different PCBs actually," Matthias mentions. "There have been so many revisions, I lost count of them. I still have a good amount

“ When Pico came out, I was amazed by the low cost and, at the same time, great performance and modifiability ”

of them here (the ones that worked). The last few board revisions, finally, were more like fine-tuning and creating a more user-friendly PCB so that everything's in one piece and easier to build (this includes the Pico being SMD-mounted for example)."

Practical sensitivity

For the detection part, Matthias told us that, technically, Geiger counters can do a similar job, and are also pretty cheap.

"What's really *the* one single benefit of having a gamma spectrometer is the energy spectrum with which you can guess what exact radioactive

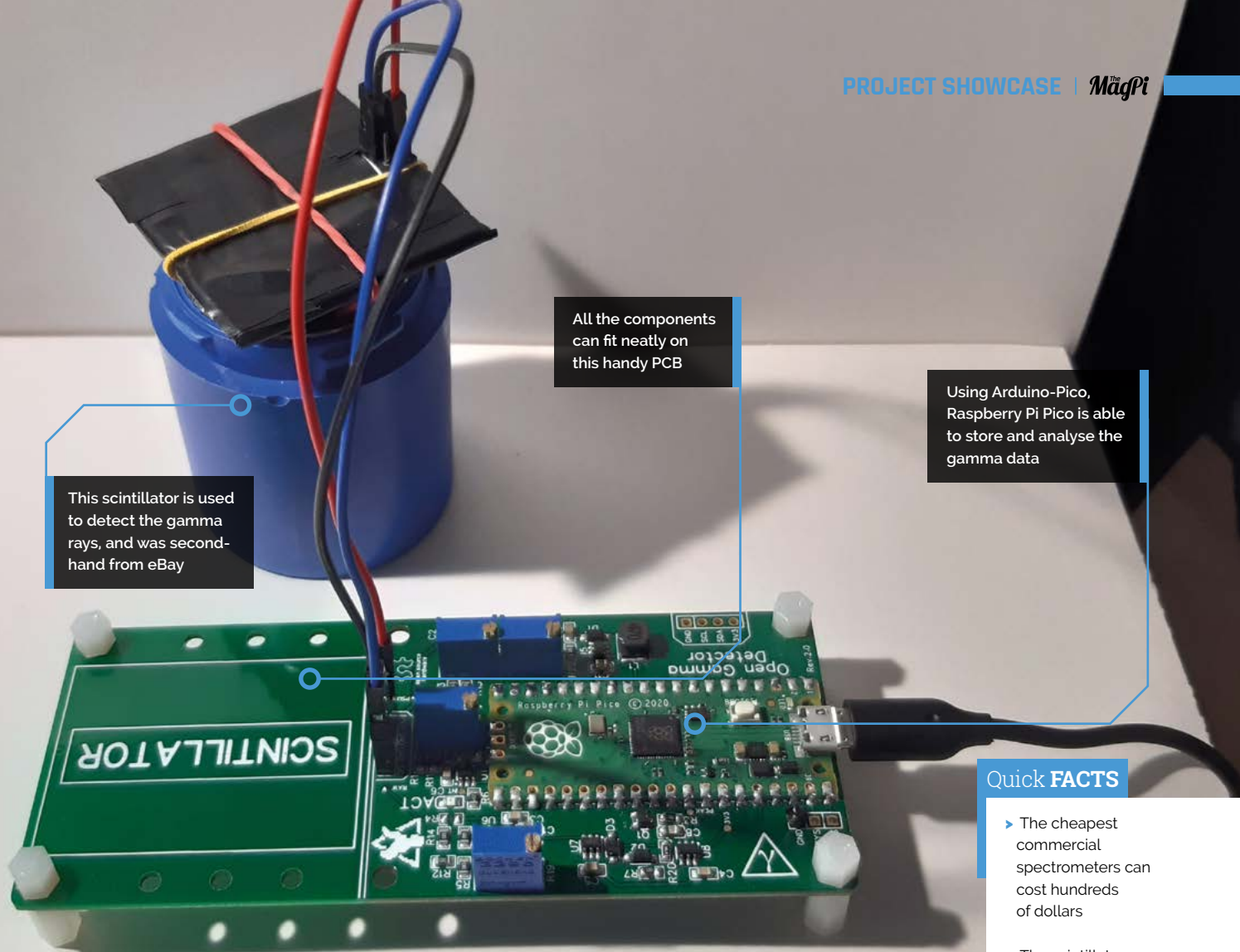

This scintillator is used to detect the gamma rays, and was second-hand from eBay

All the components can fit neatly on this handy PCB

Using Arduino-Pico, Raspberry Pi Pico is able to store and analyse the gamma data

Quick FACTS

- ▶ The cheapest commercial spectrometers can cost hundreds of dollars
- ▶ The scintillator crystal absorbs the gamma rays...
- ▶ ...and then emits blue light that the SiPM can detect
- ▶ It can be calibrated with a material that sends out known gamma energies
- ▶ Matthias wants people to understand everyday radiation



▲ The many PCB iterations that the device went through

materials are in your sample,” Matthias explains. “Got radioactive ceramics? You can easily tell if it’s from after WW2, pre-WW2, and even from the beginning of industrial pottery in the 1800s, just looking at the spectrum. Ionization smoke detector? You can tell exactly what’s in there ionizing the air. You can identify natural occurring isotopes in rocks, measure the potassium content in food, check your soil or rainwater for contaminants, and so much more.”

Check out magpi.cc/opengamma for information on how you can make your own. [M](https://magpi.cc)

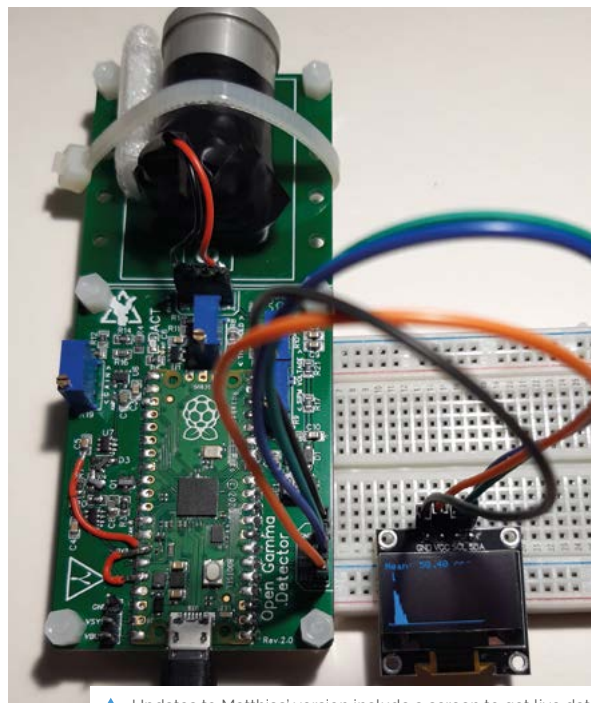

▲ Updates to Matthias’ version include a screen to get live data



SUCCESS STORY magpi.cc/success

KwickPOS

Happy customers: Raspberry Pi-based point of sale system is a hit in busy restaurant and retail settings

Houston-based KwickPOS had its first customer before it even began trading back in 2003: the owners of a Chinese restaurant looking for a slick means of fulfilling customer orders approached their IT developer friends Tom Jin and Ming Ye. Keen to oblige, Jin and Ye,

who have 20 years' experience in Silicon Valley developing restaurant software, quickly set about creating a Linux-based point of sales system that could display and process orders.

Having started out with Chinese food restaurants – “the most challenging restaurants to manage from a menu

perspective and from an organisational feedback point of view inside the restaurant,” suggests Ming Ye – word soon got out among other

restaurateurs. Demand was sufficient for the concept to become a business venture.

THE CHALLENGE

Turning a successful and in-demand point of sale system into a fully-fledged business was a leap of faith for Jin and Ye, given their existing careers in Silicon Valley. Nonetheless, in 2015, having built a number of the systems, they decided to turn KwickPOS into a “true business”, developing and selling POS systems from their Houston, Texas HQ. Having added back office support and service strategies to the POS product, they began growing their business via channel sales, distributors, merchant services, and other organisations that require sales processing capabilities.

Expensive Windows-based servers and kiosks had their limits, however, not least the cost and value to thieves of the hardware. They also take up quite a bit of room. “Some restaurant point of sale systems have three or four terminals, one of which is the actual server,” explains Ye. In more than one instance, the laptop or desktop computer has fallen foul of an opportunist thief, leaving the



business concerned with no way to take and fulfil orders.

Another issue for retail and restaurant environments is what happens if the internet connection goes down, a legitimate concern in parts of the US where power outages are not uncommon. With more and more orders arriving via email or online, business continuity and uptime are more critical than ever, as is the ability to process payments.

THE SOLUTION

With the launch of Raspberry Pi, Jin immediately saw the potential of running KwickPOS on the platform, using it as a server as well as a discreet but powerful terminal in often cramped customer kiosks and restaurants, where dining space and the number of restaurant covers need to be maximised. Since the business's existing back-end software had been Linux-based since 2013, making the switch to Raspberry Pi made good commercial sense, especially since the Compute Module cost only one tenth as much as a Windows environment. KwickPOS was able to make full use of Raspberry Pi for its cloud-based server.

Unlike most POS systems, KwickPOS is browser-based, with a server on site – something the Compute Module's compact size allows for – and the POS application display on the terminals is replicated to the cloud. A Raspberry Pi server inside each terminal processes payment data. This setup has a crucial advantage: offline mode. "If the internet goes down, that's fine," says Ye. "The manager can log in from the terminal, put it in offline mode and continue to operate the restaurant." When the internet comes back, they put it into online mode and any transactions that have already been processed will be replicated and finalised for the restaurant. "Uptime is a very strong competitive argument."

WHY RASPBERRY PI?

Jin values the fact that the Raspberry Pi Compute Module is so stable. He's frustrated by the continuing idea that using Windows is "like the law" for businesses, with many customers still using it, despite its server routinely proving to be the weak point in their setup. KwickPOS services use both Compute Module 3 and 4.

From a customer point of view, using Raspberry Pi is a great choice too. "Customers are very happy with this device," says Ye. For a start, it doesn't take up much room in an inevitably cramped



“ The company now has over 2000 customers with KwickPOS systems within their restaurants ”

restaurant service area, and is discreet enough not to attract the attention of opportunist thieves. In the rare case a unit has been stolen, the business can continue to operate, since the Raspberry Pi web server takes the strain. As well as ensuring the business doesn't lose out financially due to lack of connectivity, the system still operates as though it were connected, and the customer can drop in a like-for-like replacement unit without losing any data.

KwickPOS has also expanded its customer base to include boutique retail stores. As with independent restaurants, the need to quickly and efficiently take and process orders is paramount. Importantly, KwickPOS is platform-agnostic. With handheld payment terminals now commonplace, KwickPOS is able to slot in to a store's existing setup.

THE RESULTS

Since making the switch to Raspberry Pi in 2018, KwickPOS has grown to become an organisation that has customers across 45 US states, as well as in Canada and Mexico. There is even a Chinese restaurant in London, UK using the system. The company now has over 2000 customers with KwickPOS systems within their restaurants, ranging from single units to retail chains. 

SUBSCRIBE TODAY FOR JUST £10

Get 3 issues + FREE Pico W



Subscriber Benefits

- ▶ **FREE Delivery**
Get it fast and for FREE
- ▶ **Exclusive Offers**
Great gifts, offers, and discounts
- ▶ **Great Savings**
Save up to 35% compared to stores

Subscribe for £10

- ▶ Free Pico W
- ▶ 3 issues of The MagPi
- ▶ Free delivery to your door
- ▶ £10 (UK only)

Subscribe for 6 Months

- ▶ Free Pico W
 - ▶ 6 issues of The MagPi
 - ▶ Free delivery to your door
- | | |
|----------|---------------------|
| £30 (UK) | £35 (USA) |
| £35 (EU) | £45 (Rest of World) |

☎ Subscribe by phone: **01293 312193**

📍 Subscribe online: **magpi.cc/subscribe**

✉ Email: **magpi@subscriptionhelpline.co.uk**

Subscribe for £10 is a UK-only offer. The subscription will renew at £15 every three months unless cancelled. A free Pico W is included with a 6-month subscription in USA, Europe and Rest of World.

SUBSCRIBE TODAY AND GET A

FREE Raspberry Pi Pico W

Subscribe in print today and get a **FREE** development board

- ▶ A brand new RP2040-based Raspberry Pi Pico W development board
- ▶ Learn to code with electronics and build your own projects
- ▶ Make your own home automation projects, handheld consoles, tiny robots, and much, much more



This is a limited offer. Not included with renewals. Offer subject to change or withdrawal at any time.



Buy now: magpi.cc/subscribe



SUBSCRIBE
on app stores

From **£2.29**

Available on the
App Store

GET IT ON
Google Play

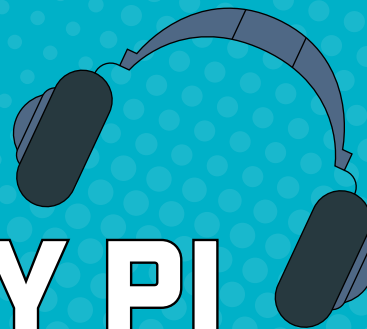
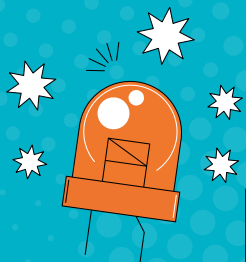

RASPBERRY PI BUYERS GUIDE 2023

TREAT YOURSELF THIS HOLIDAY SEASON
TO THE BEST OF RASPBERRY PI.
BY LUCY HATTERSLEY

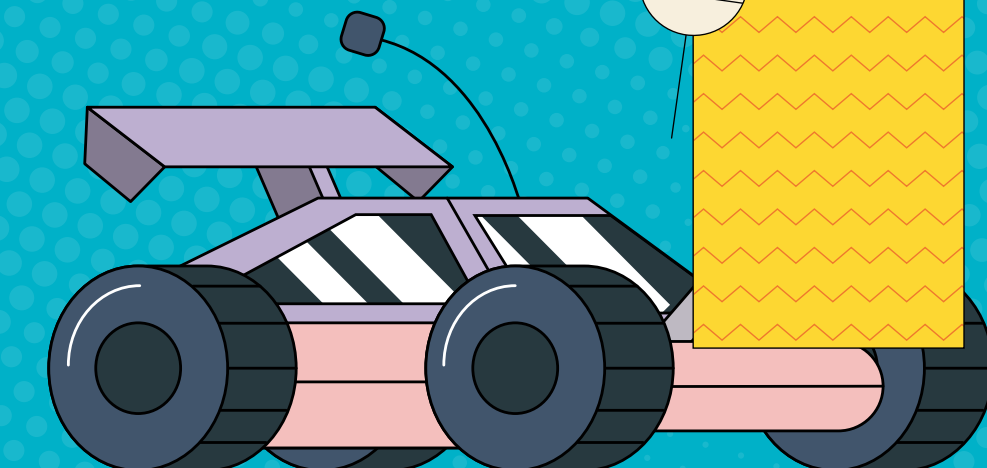
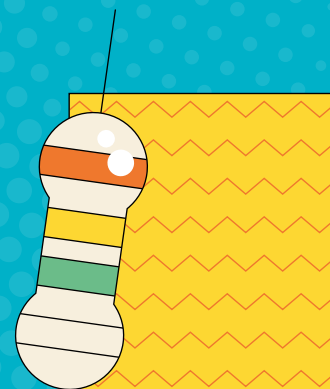
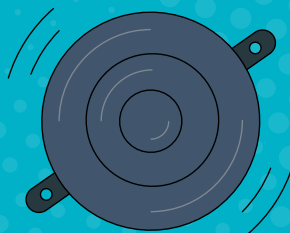
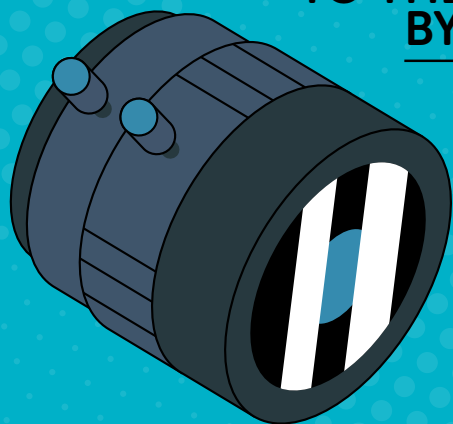

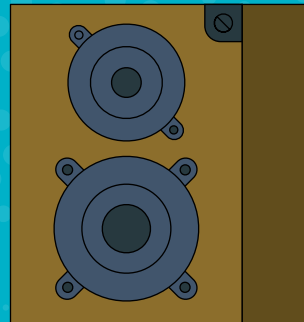
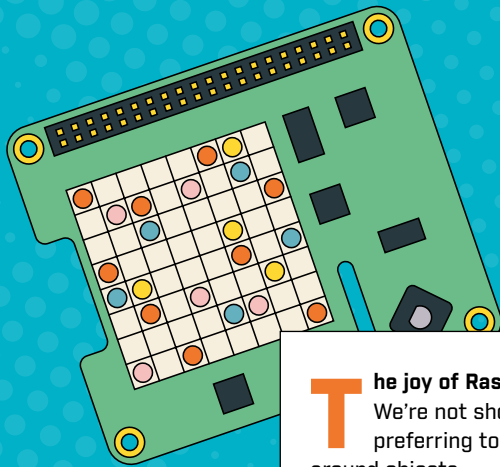
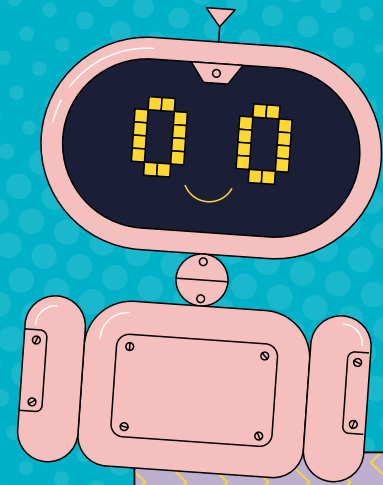
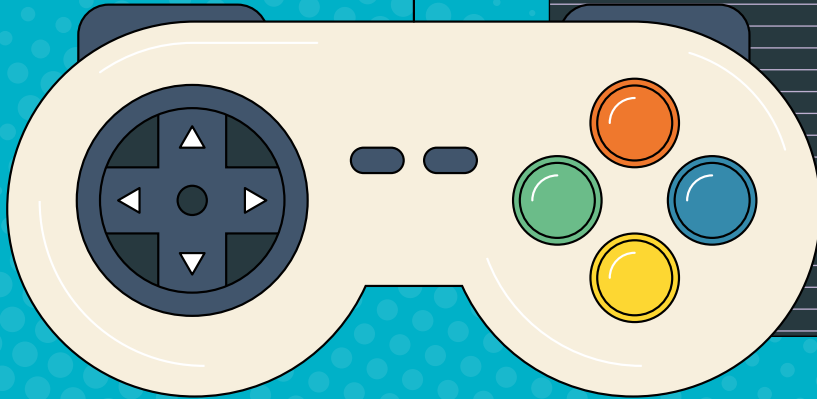

The joy of Raspberry Pi lies in the making. We're not shoppers by heart, instead preferring to hack and mend our way around objects.

Even so, this is our hobby and, like any other, it can be a huge amount of fun. So let's not worry too much about buying some wonderful things to go alongside our favourite tech computer.

“ A few things you can pop under the tree for yourself ”

An entire industry has grown around Raspberry Pi, with home projects, artificial intelligence equipment, electronics kits, and just about every type of gizmo and gadget you can imagine.

In fact, pretty much the hardest thing to buy at the moment are Raspberry Pi computers themselves. But don't worry. We have some great advice on that front.

So, let's get ready for the holiday season with a few things you can pop under the tree for yourself.

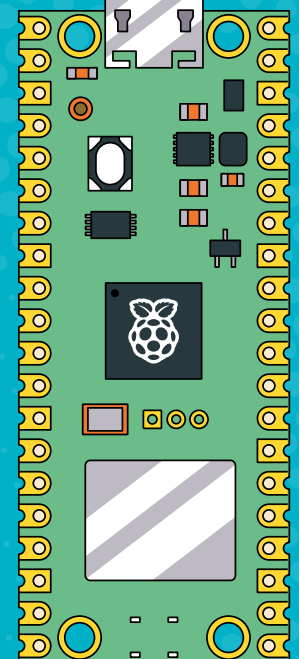

COMPUTERS & MOTORCONTROLLERS

GET YOURSELF A RASPBERRY PI

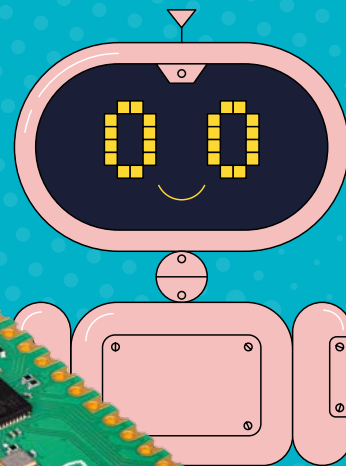
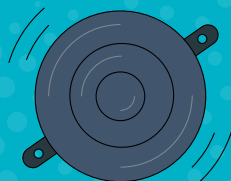
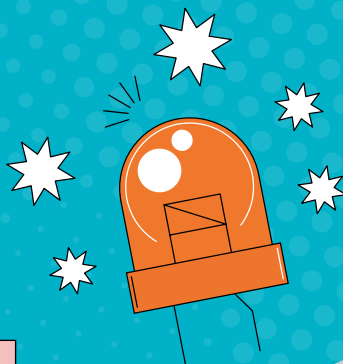
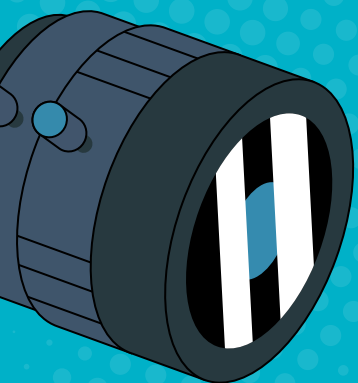

RASPBERRY PI 4

The main computer is Raspberry Pi 4 Model B. This is your tiny computer with dual-display ports and enough processing power to act as a full desktop. Available with 1GB, 2GB, 4GB, and now even 8GB RAM, you get a fast processor and a 40 GPIO header (populated with pins so you can quickly start attaching kit and components). Pricing starts at \$35, although you'll pay more for a 4GB or 8GB version.

• magpi.cc/raspberrypi4

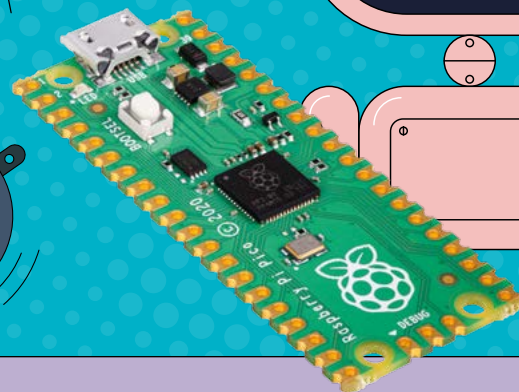

RASPBERRY PI PICO W

This microcontroller packs a huge amount of the functionality of Raspberry Pi into a tiny, low-cost (from \$10) board. There are 40 pins on Pico W, so you can wire it into electronics kit and projects. The new Pico W model has Wi-Fi built into it for deployment around the home or office. While you can't run Pico W as a full desktop computer, it connects to your PC, Mac, or another Raspberry Pi for programming.

• magpi.cc/picow



RASPBERRY PI 400

We love Raspberry Pi 400. It packs all the power of Raspberry Pi 4 inside a keyboard with 40 GPIO pins at the back. This is our favourite computer for home use and is perfect for desktop and retro computing projects. You can buy the computer itself, or a Raspberry Pi 400 Starter Pack that comes with power supply, mouse, and a *Beginner's Guide* book.

• magpi.cc/raspberrypi400

SKU	Description	Link	Update Status	Vendor	In Stock	Last Stock	Price
CM4108032	RPI CM4 - 8GB RAM, 32GB MMC, With WiFi			BerryBase (DE)	Yes	04-Nov-22 (EUR)	120.52
CM4102032	RPI CM4 - 2GB RAM, 32GB MMC, With WiFi			BerryBase (DE)	Yes	04-Nov-22 (EUR)	69.78
CM4002016	RPI CM4 - 2GB RAM, 16GB MMC, No WiFi			BerryBase (DE)	Yes	04-Nov-22 (EUR)	57.08
CM4002000	RPI CM4 - 2GB RAM, No MMC, No WiFi			BerryBase (DE)	Yes	04-Nov-22 (EUR)	44.40
CM4001032	RPI CM4 - 1GB RAM, 32GB MMC, No WiFi			BerryBase (DE)	Yes	04-Nov-22 (EUR)	57.08
CM4001016	RPI CM4 - 1GB RAM, 16GB MMC, No WiFi			BerryBase (DE)	Yes	04-Nov-22 (EUR)	50.28
CM4001008	RPI CM4 - 1GB RAM, 8GB MMC, No WiFi			BerryBase (DE)	Yes	04-Nov-22 (EUR)	44.40

WHERE TO FIND RASPBERRY PI?

Due to the ongoing supply chain shortage, it can be tricky locating the Raspberry Pi model you need at the moment (Raspberry Pi CEO Eben Upton wrote about this issue earlier in the year: magpi.cc/supplychainupdate).

Some models have better supply than others. Raspberry Pi Pico W is in good supply, along with Raspberry Pi 400, and then Raspberry Pi 4 Model B is intermittently available if you keep an eye open. Raspberry Pi Zero models are hard to come by at the moment.

Sign up with RPI Locator (magpi.cc/rpilocator) to find which official resellers have stock.



It can be tricky locating the Raspberry Pi model you need at the moment

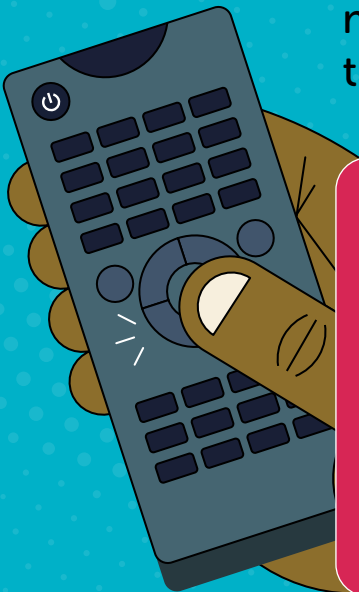

HEAD TO THE STORE

Raspberry Pi models are in supply at Raspberry Pi's physical store at the Grand Arcade, Cambridge (magpi.cc/retailstore). There is a limit of one model of Raspberry Pi per customer, but you'll also find a huge range of accessories and gadgets to play with. There is also a large choice of merch like T-shirts and mugs, and all the excellent books and magazines we make. It's a fantastic place to visit.



RASPBERRY PI ACCESSORIES

TAKE A LOOK INTO THE WORLD
OF OFFICIAL ACCESSORIES

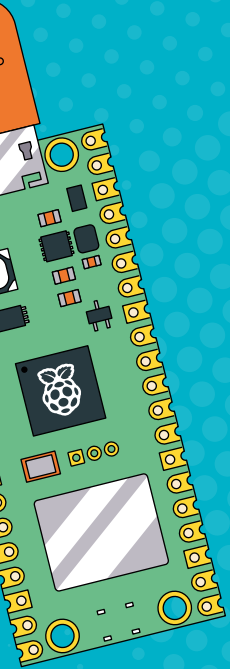
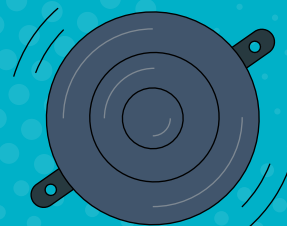

Give Raspberry Pi the gift of sight by attaching a camera

CAMERA

Give Raspberry Pi the gift of sight by attaching a camera to its built-in CSI (camera serial interface). Raspberry Pi has a range of different cameras available, starting with the Camera V2 (magpi.cc/camera). It's perfect for stop-motion and wildlife capture projects. There is also a Camera NoIR for capturing images in dark areas.

The Raspberry Pi High Quality Camera (magpi.cc/hqcamera) comes with a C- and CS-mount for attaching professional lenses. Detailed information on cameras can be found on the Raspberry Pi documentation page (magpi.cc/cameradocs). You can also get a range of tutorials and advice in our free Raspberry Pi Camera Guide.

• magpi.cc/cameraguide

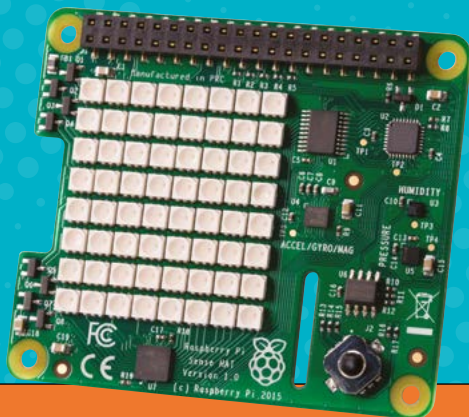

SENSE HAT

The Sense HAT is one of the biggest and most interesting pieces of hardware you can attach to Raspberry Pi. As part of the Astro Pi space mission, two Raspberry Pi computers, and Sense HATs, are placed on board the International Space Station (astro-pi.org). It's packed with sensors, an LED matrix, and has a joystick. There are hundreds of projects for it.

• magpi.cc/sensehat





WHAT IS A HAT?

HATs stand for Hardware Attached on Top. These are boards that connect to the GPIO pins on your Raspberry Pi. In order to be called a HAT, they should contain a custom EEPROM that contains all the code they need to work.

RASPBERRY PI TOUCH DISPLAY

This 7-inch touch display can be used for interactive projects like tablets, entertainment systems, and information dashboards. It connects to Raspberry Pi via the DSI socket and provides an 800 × 480 resolution screen with multi-touch input.

• magpi.cc/touchdisplay

RASPBERRY PI TV HAT

One of the lesser-known HATs is this TV HAT that enables you to receive digital DVB-T2 TV streams on your Raspberry Pi to view them, or stream them over a network to other devices. It's a fun device for interacting with digital television.

• magpi.cc/tvhat

BUILD HAT

LEGO and Raspberry Pi are an ideal match, and Build HAT brings the two together. With one of these HATs (Hardware Attached on Top), you can control up to four LEGO Technic motors and sensors from the LEGO Education SPIKE Portfolio. It's an ideal way to blend the computing power of Raspberry Pi with fun construction bricks.

• magpi.cc/buildhat

AUDIO HATS

Fancy turning Raspberry Pi into a high-end sound system? DACs (digital-to-analogue converters) are used to create high-end sound systems from digital components. Raspberry Pi has a range of DACs as part of its Audio range. The Raspberry Pi DAC Pro model uses the Texas Instruments PCM5242 and supports balanced/differential output in parallel to phono/RCA line-level output. It includes a dedicated headphone amplifier.

• magpi.cc/iquadipro

RASPBERRY PI STARTER PROJECTS

GREAT EQUIPMENT TO GO ALONGSIDE
YOUR NEW RASPBERRY PI COMPUTER

ELECTRONICS KIT

At the heart of Raspberry Pi is the digital connection between code and the world of electronics. So it makes sense that one of your first kits will contain pure electronic components. Remember getting your first electronics kit? It's like that, with Python code on top.

There is a huge range of Raspberry Pi electronics kits around. The CamJam EduKit (£6, magpi.cc/edukit) is a perennial favourite. With a breadboard, buttons, LEDs, jumper cables, and an instruction book; it walks you through your first projects.

If you want to explore electronics with Raspberry Pi Pico, then SB Components' Pico Breadboard Kit (£14, magpi.cc/picobreadboardkit) is a board with buttons, LEDs, and a half-breadboard fixed in that can be interfaced with Pico.

If you want a kit that goes beyond LEDs and buttons, then check out WaveShare's MicroPython Learning Kit (£30, magpi.cc/micropythonlearningkit). It includes a pre-soldered Raspberry Pi Pico, sensors, buttons, and an RGB display.



MEDIA PLAYER

Similar to the retro gaming project is building a media player. Sometimes they even use the same software, so you can build a media player and retro gaming box to sit under your television.

For this you'll need a remote control, like the Argon Remote (£14, magpi.cc/argonremote) or Mini Remote Control (£4, magpi.cc/miniremote). Take a look at our free Build a Media Player book (magpi.cc/mediaplayer).

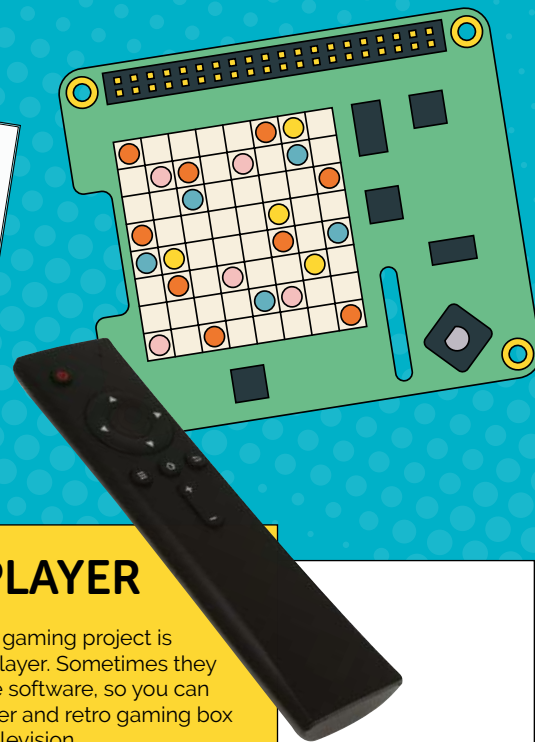

WHEELED ROBOT

Oh to build our first robot all over again! A great low-cost place to start is with the CamJam EduKit #3 (£20, magpi.cc/edukit3). It is facing swift competition in the wheeled robot race from Pico-based newcomers like the Kitronik Autonomous Robotics Platform for Pico (£40, magpi.cc/kittronikrobot). There are more powerful robots around, such as pi-top's Robot Kit or the GoPiGo 3. Or, you can roll your own robot with a motor board, wheels, and some servo motors. Take a look at our Build a Super Simple Robot feature in *The MagPi* magazine issue 120 (magpi.cc/120).



RETRO GAMES CONSOLE

The popularity of building a retro games console with Raspberry Pi is so commonplace, it's almost become a meme.

Still, few projects have as much instant satisfaction as turning your favourite small computer into a classic video games console or retro computer. All you need is a copy of RetroPie (retropie.org.uk) and a controller like The Pi Hut's Wireless Game Pad (£14, magpi.cc/wirelessgamepad).

RETRO GAMING WITH PICO

If you'd like to see what's possible with Retro Gaming on Raspberry Pi Pico, take a look at *The MagPi* magazine issue 122.

• magpi.cc/122



RETRO GAMING

To build your own arcade machine, and explore retro gaming with Raspberry Pi, take a look at our book on *Retro Gaming with Raspberry Pi*.

• magpi.cc/retrogamingbuy



LED LIGHTS

Throw some smart lights around the home. Lighting is another project that is incredibly easy to set up and offers impressive results. You can either take over your home lighting system, Philips Hue-style, or connect a string of LED lights to Raspberry Pi and use them to jazz up various items around the house (from stairs, to your television, to lighting up smart shelving). All are colour-coordinated and controlled by Raspberry Pi. See our guide to controlling smart lights at home (magpi.cc/lightfantastic) or build a Sunrise Lamp (magpi.cc/sunriselamp).

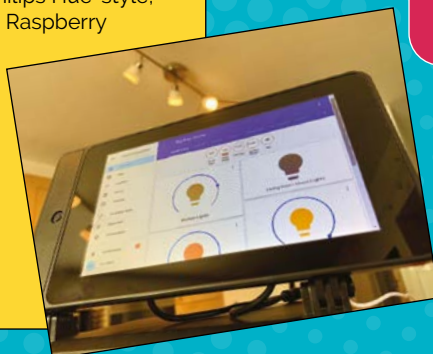



TREAT YOURSELF

BIG PROJECTS THAT ARE SPECTACULAR TO BUILD

ARCADE MACHINE

Retro gaming is lots of fun, but why not go the whole hog and build your own arcade machine? Retro expert KG Orphanides put together a multi-part build guide that is collected in our *Retro Gaming with Raspberry Pi* book (magpi.cc/retrogaming). The end result is spectacular, and would have pride of place in any gamer's home.

If you want to buy a pre-built arcade machine, then Picade has long ruled this particular roost. Its Picade Console (£90, magpi.cc/picadeconsole) is a Raspberry Pi-powered box with an arcade-quality stick and buttons that plugs straight into a HDMI TV or monitor. Meanwhile, its Picade (magpi.cc/picade) is available with an 8-inch display (£195), or 10-inch display (£249), or a full 10-inch kit comes complete with Raspberry Pi 4 8GB unit, PSU, and 32GB SD card (£330).

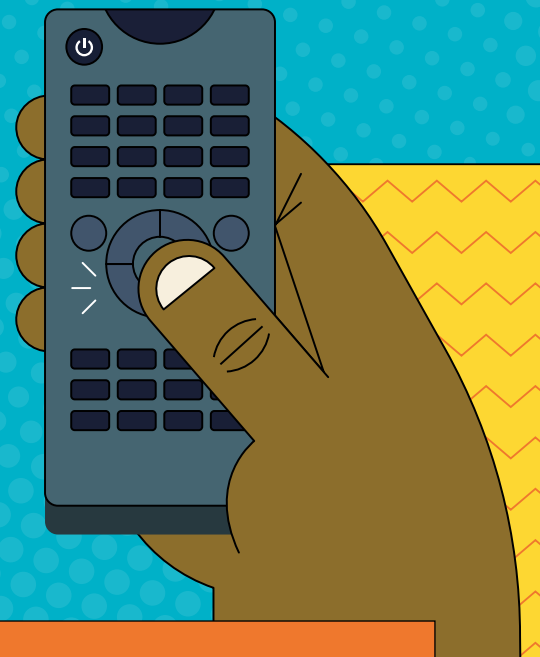

POWERFUL ROBOTICS

There is a world of difference between a starter robot and a big kit with all the bells and whistles. Why not take a look at PiBorg's range, including the MonsterBorg (£249, magpi.cc/monsterborg)? It's a seriously fast-wheeled robot. The M.A.R.S Rover is a recreation of the Mars Perseverance robot (£144, magpi.cc/marsrover) although you will need to source a Raspberry Pi Zero for it. Meanwhile, Spider-Pi is a terrifying six-limbed AI-powered robot kit (£536, magpi.cc/spiderpi). And a recent favourite of ours is Peto Bittle (£310, magpi.cc/petobittle), a four-legged, tiny recreation of Boston Dynamics' Spot.

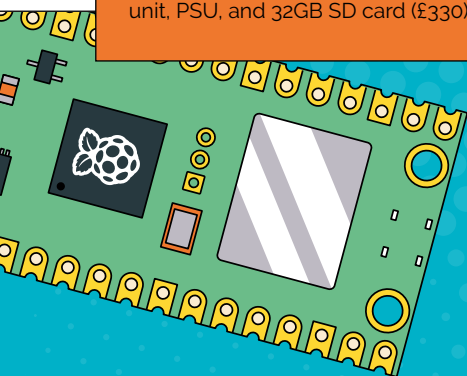

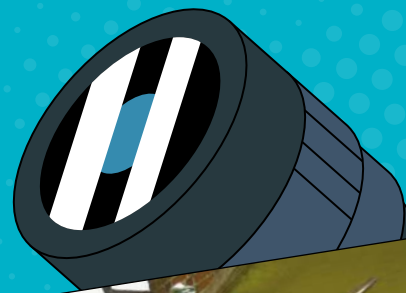

LAPTOP

Raspberry Pi makes for an incredible laptop. It performs all the tasks a regular notebook does and, thanks to its GPIO pins, it can do a whole lot more. The right laptop kit is perfect for either the coffee shop or the hackathon.

There are two main kits available. The company pi-top (pi-top.com) makes the pi-top [4] kit which consists of a separate case, screen, and keyboard (read our review at magpi.cc/pitopfhd). It's a stylish – if not particularly low-cost – solution (the whole kit costs around £400). But it doesn't look out of place in the coffee shop. The case also connects to a superb pi-top Robotics Kit (magpi.cc/pitoprobot).

Meanwhile, the other laptop solutions we've found with charm are those made by CrowPi. There is the CrowPi Compact (\$238, magpi.cc/crowpi) and newer CrowPi L (\$239, magpi.cc/crowpil). CrowPi L looks like a chunky laptop, and you can buy an electronics kit to go alongside.

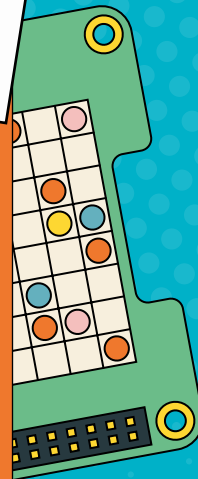

NATUREBYTES

Wildlife enthusiasts will adore this stealth outdoor camera that can be deployed to take pictures of critters in the great outdoors. The kit version comes with a Raspberry Pi A+ and enables you to quickly deploy a weatherproof camera trap for shy critters.

• magpi.cc/naturebytes

Raspberry Pi makes for an incredible laptop

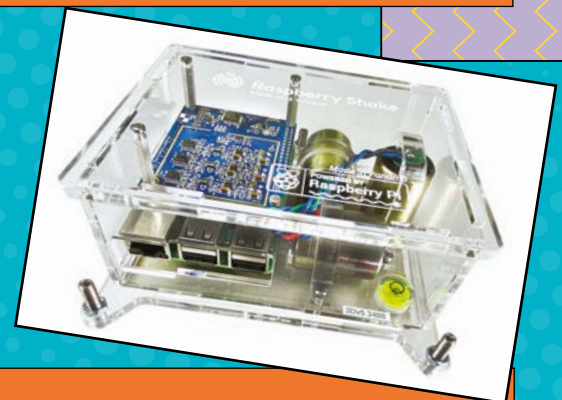

RASPBERRY SHAKE

This neat project uses professional-grade seismograph and infrasound monitors to record and visualise earth tremors. It is used to monitor earthquakes (large and small around the world) and both natural and human activity. It is a great educational tool that can be used to monitor neighbourhood activity (such as washing machines or traffic levels). Once deployed, you get to hook it up to a wide network of Shake devices around the world. magpi.cc/shake

• magpi.cc/shake

PICOSYSTEM

PicoSystem is a pocket-sized, handheld games console built around a Raspberry Pi RP2040 chip (the microcontroller at the heart of Raspberry Pi Pico). It comes with a small 1.5-inch display, D-pad, and buttons. It's a great way to play retro-style and homebrew video games, and you can learn to make your own using the PicoSystem API.

• magpi.cc/picosystem



MicroPython Handheld: Make a game



Program a tiny survival game in MicroPython.
Find food. Hide from the flood

MAKER

K.G. Orphanides

KG is a writer, developer, and software preservationist with a particular interest in projects that allow everyone to get hands-on with their own games and technology.

magpi.cc/hauntedowlbear

You'll Need

- ▶ MicroPython Handheld magpi.cc/123
- ▶ Thonny Python IDE thonny.org
- ▶ Pi Pico Game Boy drivers and tools magpi.cc/picogbgit

This month, we'll start writing a game for our Raspberry Pi Pico-powered handheld. Hungry Rain is a tiny survival game in which you control dot, who must find food and avoid the flood to stay alive. We'll use libraries created by Vincent Mistler of YouMakeTech to handle inputs and address the ST7789-compliant LCD display. This tutorial assumes you've already copied these tools to your MicroPython Handheld's Pico; if you haven't, git clone the magpi.cc/picogbgit repository and copy all the files from its root directory to Pico. A handful of other instructions presume you're using a Linux distro such as Raspberry Pi OS on your development computer, but work in a similar fashion on a PC.

01 Have a sprite

During development, the game's sprites – little graphics to represent the player, food, and in-game objects – were the last things that we added. Instead, we used MicroPython's `fill_rect` function to create little squares of pixels to represent food, structures, and our protagonist, dot. This technique of prototyping with primitive shapes is widely known as 'greyboxing'. It's extremely useful but not very interesting to look at, so, for the purposes of this tutorial, we're going to dive right in and make some sprites. The latest version of YouMakeTech's PicoGameBoy class file now includes an `add_rect_sprite` method to create blank sprite placeholders, which you should use instead.

02 Sprite preparation

Both free and paid-for asset packs are widely available. Most of our sprite graphics are modified from Kenney Game Assets 1. You can freely download and donate for Kenney's excellent asset packs at magpi.cc/kenneyassets. Once you've chosen an image asset, open it in GNU Image Manipulation Program (magpi.cc/gnuimage). Our handheld has a tiny 240 × 240 pixel display, so keep everything small. If, for example, you're starting with a 128 × 128 px image of an apple on a transparent background, open the Image menu and select Crop to Content, dropping its size to 68 × 74 px. Then go to Image > Scale image and change its width to 14 px. Change your view to 800% magnification and use the fill tool to give it a background colour, as our converter does not support transparency.

03 Sprite conversion

From the File menu, select Export as, and set it to PNG format. In the Export Image as PNG dialog box, click the pull-down menu that is by default set to automatic pixel format, and choose 8bpc RGB. Now click Export, saving it somewhere convenient. Finally, we'll convert the PNG into a raw RGB 565 bytearray for use with the Waveshare display module we put in our handheld. Copy `png2fb.py` from the `Utils` directory of the Pi-Pico-Game-Boy repo into your `graphics` directory. Open a Terminal and `cd` to that directory. You're running Thonny, so Python 3 should already be installed,

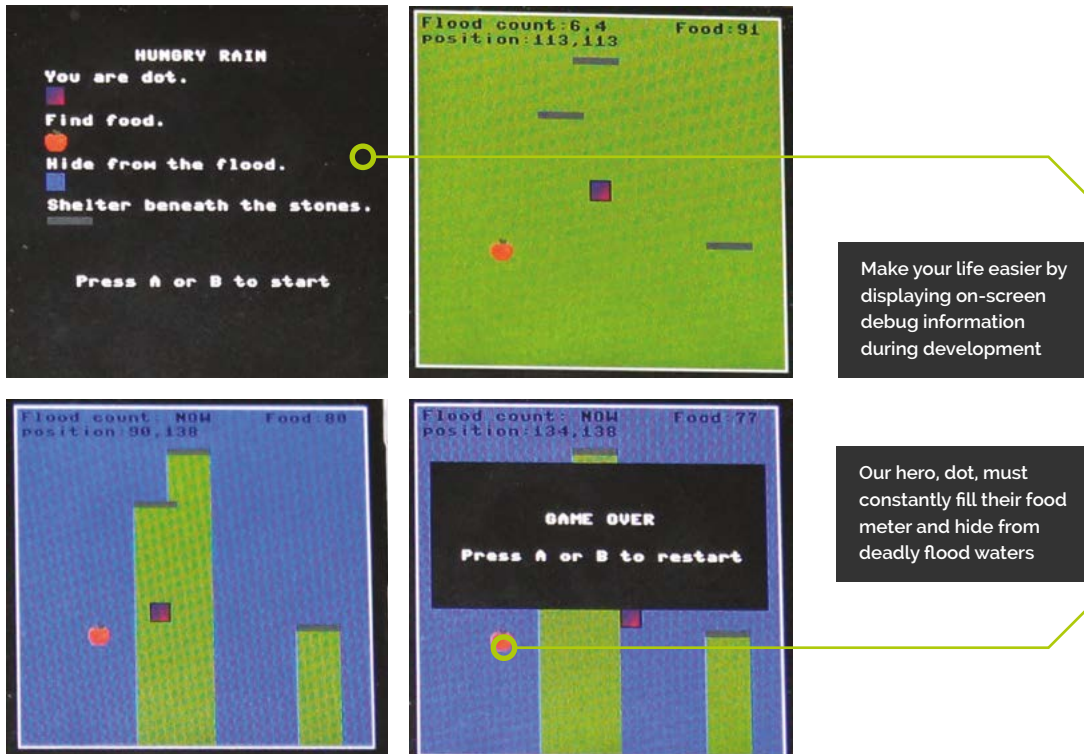

but you may need to `pip install pillow`. Then type `python3 png2fb.py your_file_name.png` and copy the string it spits out, starting with 'bytearray' and ending with a ' '.

04 Defining dot

Every game needs a protagonist. Ours is dot, an unassuming, but colourful 14×14 px square. Their sprite is defined in our code under `#sprites` and assigned as the third sprite in our set, numbered 2. Dot starts at the middle of the screen, so we initialise their x, y coordinates at 112,112 (the actual central location is 119,119, but dot is a 14 px square.) Every time dot moves, we save their last position to variables called `last_x` and `last_y`. We'll need these to stop them from walking through walls. We've also stored their width and height for use in collision detection calculations.

Down in our main game loop, we draw dot with the `pgb.sprite(2,x,y)` instruction. Below that, you'll find the movement code, in which pressing the direction buttons shifts dot by plus or minus one. Note that position 0,0 is the far top left of the display.

05 Boxing in your world

This is a single-screen game and we don't want the player to go off the edges. We've drawn a white box using `pgb.rect(1,1,239,239,BOX_COLOR)`. `BOX_COLOR` is defined at the beginning of our program, with other settings that only need to be

“ This is a single-screen game and we don't want the player to go off the edges ”

configured once, such as colours, timers, and some randomised locations.

We stop dot from going past the box by checking whether they're at a set of fixed x and y coordinates. If so, we replace dot's projected position in the framebuffer with our previously saved `last_x` or `last_y` coords. This has to happen after the directional button press handling routine.

Top Tip

Graph it out

If you're having trouble working out relative positions or plotting collision detection, drawing stuff out on graph paper really helps.

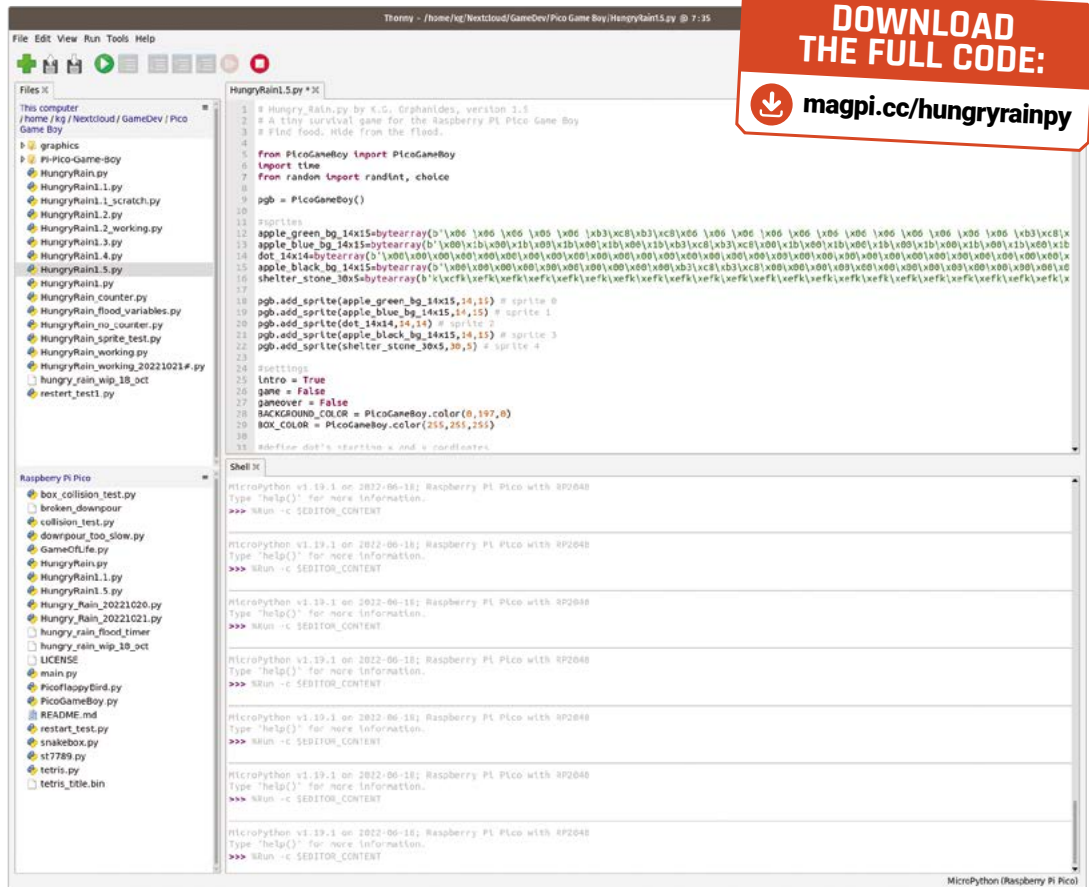

► The Thonny IDE makes it easy to program Raspberry Pi Pico, but remember to use the 'Save as' option to avoid accidentally saving over functional code

06 Stay hungry The first challenge dot will face is staying alive. They start with a food counter set at 100, which goes down by one every second. If it reaches zero, the game is over. Apples appear on the playing field, adding 10 to the counter every time dot eats. We've used the `randint` function to ensure that food spawns at x and y coordinates within our bounding box, and we've used a `Food_available = True/False` Boolean to ensure that only one piece of food appears at a time, as soon as the previous one is eaten. We use a collision detection function to see if dot has touched the food.

07 Super collider That function, `def collision (x1,y1,w1,h1,x2,y2,w2,h2)`, requires dot's x, y, width and height coordinates, and those of the thing that we want to check to see if dot overlaps. If dot's x position and width are less than the x coordinate of our object, then no collision has occurred. The same applies to the sum of the

object's x and width are less than dot's x. That handles collision detection on the horizontal axis. We'll do the same, only with y coordinates and height, to check for vertical intersection. This kind of AABB (Axis-Aligned Bounding Box) collision detection can be used in any game that involves non-rotational rectangular objects such as platforms or walls. We've used it to detect collisions with food, shelters, and flood water.

08 Floodland So far, all dot has to do is avoid starving to death. We're going to add a bit of challenge with a flood that will destroy dot on contact, ending the game. When `flood = True`, the background colour turns blue. The length of this is defined by the `flood_delay` and `flood_duration` variables in the game's settings. We've created a flood with a ten second (10,000 millisecond) `flood_duration`. This occurs every 15 seconds, defined by `flood_delay`. (You might need to lengthen that if you don't want your friends to destructively rage-quit the game.)

Top Tip 🍷

Extra instructions

The latest version of the core `PicoGameBoy.py` class from YouMakeTech now includes documentation and examples of how to use it. Give it a read!

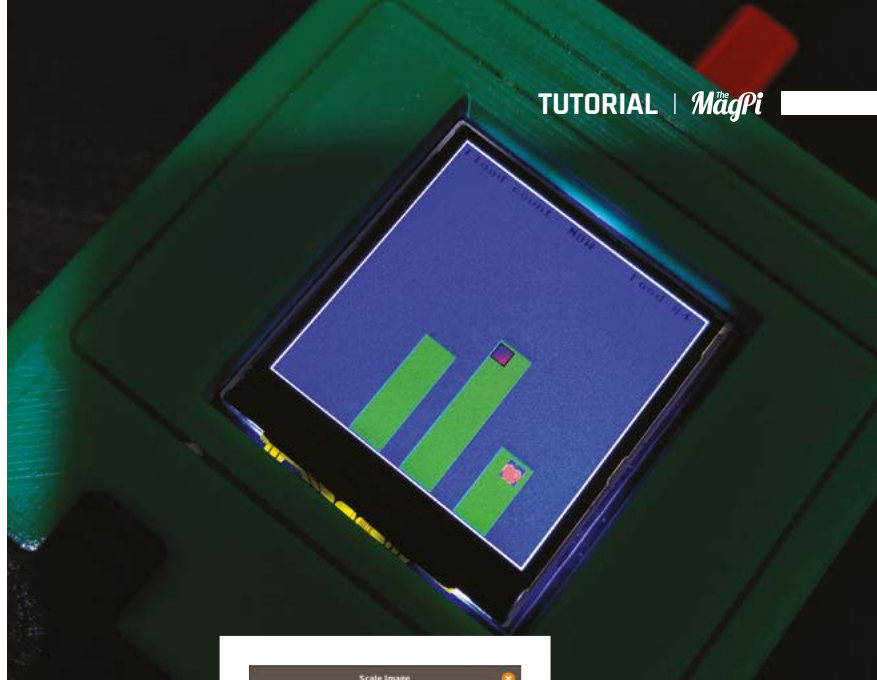

Now, let's give dot somewhere to hide and arrange for their demise.

09 Gimme shelter

We've defined three shelters, whose positions are randomly determined every time the game starts. Rather than using a simple range, we've used MicroPython's `choice()` function to exclude dot's default spawn area, so that they can't spawn stuck in the middle of a rock. The shelters have an overhang extending to the bottom of the playing field that prevents the flood water from touching dot. The areas they shelter remain green during floods, while the rest of the playing field turns blue. If you look at our `# water is deadly` code, you'll see our collision detection routines, this time invoked to trigger a game over if dot no longer intersects with the rectangular shelter overhangs.

10 Heads up

We've created a pair of counters visible at the top of the screen: a rudimentary heads-up display that tells you how long until the next flood, and how long until dot runs out of food. During development, we implemented a lot of extra displays to help us spot bugs, including the positions of dot's x and y coordinates, food and shelter, the current time, and the direction dot was moving in. You can also print debug data to

the MicroPython shell, but it's easier having it right in front of you. We determined many positional limits using an on-screen coordinate display.



▲ Playing Hungry Rain on the MicroPython Handheld

◀ Scale images down to an appropriate size in a graphics program. You may need to do some fine-pixel editing to work with the low 240 x 240 resolution

11 Beginnings & endings

Hungry Rain isn't what you'd call a complex game, but a title screen with some elegantly worded instructions can add both flavour and clarity. We've added an intro screen as a separate game loop, telling players what they're supposed to do. The game over screen when they lose is at the top of the main game loop, and uses the somewhat brute-force approach of a soft reboot to start a new game, ensuring that the shelters get a new random position every time.

12 Future developments

At the time of writing, Hungry Rain stands at version 1.5, but there's a lot that could be done to enrich this simple framework of a game. Extra food, shelters that wear out over time, flood water that destroys food, selectable difficulty that changes the length of time between floors, a score, and a more elegant restart loop are all options we considered. You could even throw in enemies, if you don't feel that a game is complete without conflict. [\[7\]](#)

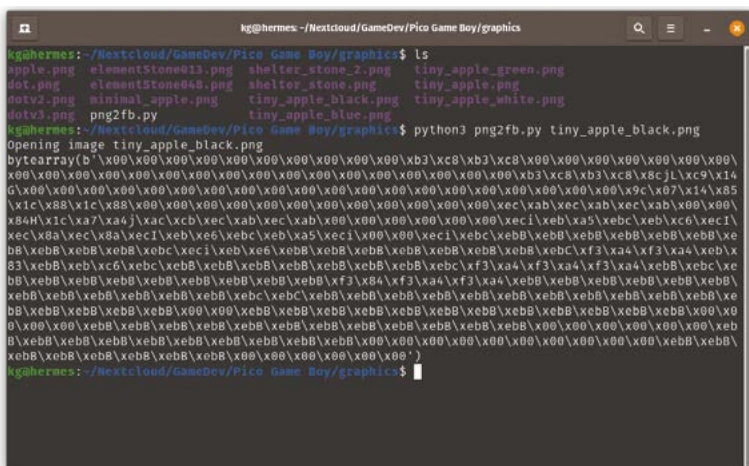

▲ YouMakeTech's Pi-Pico-Game-Boy GitHub repo includes `png2fb.py`, a utility to convert a PNG image into a bytearray to feed the framebuffer for the ST7789 display

Pico W IoT with Anvil: Plot sensor data



Phil King

Long-time contributor to *The MagPi*, Phil is a freelance writer and editor with a focus on technology.

@philkingeditor

Store sensor data sent from Pico and plot graphs in an Anvil web app

Anvil's Pico W IoT toolkit enables you to connect easily, and securely, to web apps you create. Using the Anvil UF2 firmware image, you can code programs on Pico W in MicroPython, with a few extra lines to connect to Anvil, then create a web app on the Anvil site which can send and receive data to/from your Pico W program.

Last issue, we sent DHT11 temperature and humidity sensor readings from Pico and displayed the readings in a web app dashboard. This time, we'll plot the data in graphs.

▼ **Figure 1:** the wiring diagram for the circuit using a DHT11 temperature and humidity sensor

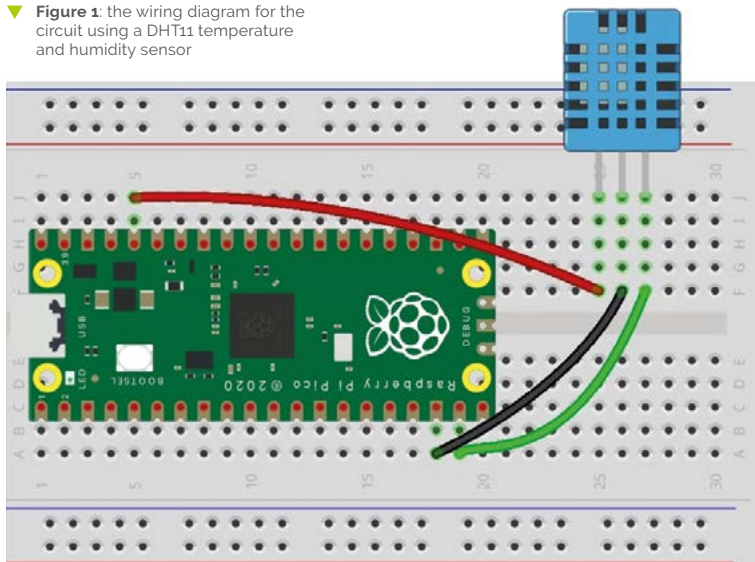

01 Install the firmware

If you already have a Pico W with the Anvil firmware installed and connected to your wireless network, you can skip the first two steps of this guide.

To link your Pico W to the Anvil framework, you'll need to use Anvil's special firmware file. Go to magpi.cc/anviluf2 and download the latest 'complete' UF2 file. (If you want to avoid overwriting any existing files on Pico W, use the 'firmware-only' version.)

Hold Pico W's BOOTSEL button while connecting it to a computer via USB, then drag the UF2 file to the mounted 'RPI-RP2' volume. Once it's copied across, Pico W will automatically reboot and reappear as a volume called 'Pico W'.

02 Connect to Wi-Fi

With Pico W connected to your computer, open up the Thonny IDE and make sure the Python interpreter (shown at the bottom right) is set to 'MicroPython (Raspberry Pi Pico)'. The **main.py** file on Pico W will run automatically, so you will need to stop it by pressing the Stop icon. Open the **boot.py** file and enter your wireless router's SSID (name) and password at the top.

```
WIFI_SSID = "<put your network name here>"
WIFI_PASSWORD = "<put your wifi password here>"
```

Now when Pico W reboots, it'll automatically connect to your wireless network.

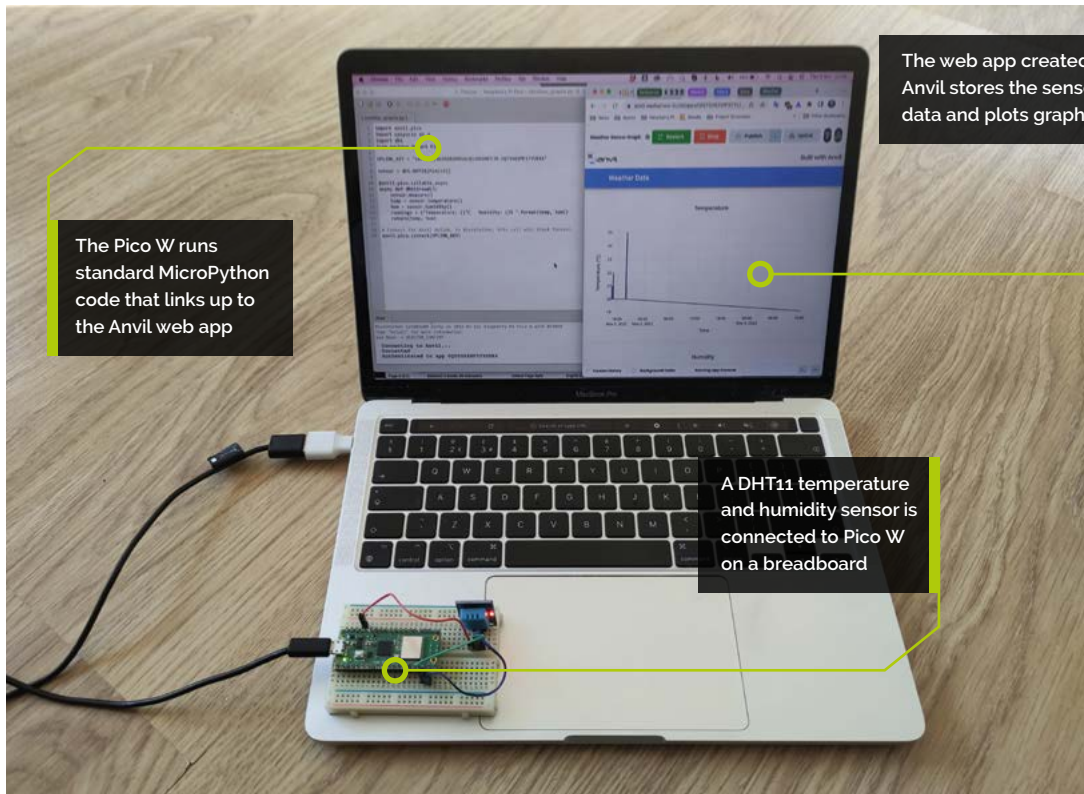

The Pico W runs standard MicroPython code that links up to the Anvil web app

The web app created on Anvil stores the sensor data and plots graphs

A DHT11 temperature and humidity sensor is connected to Pico W on a breadboard

Top Tip

Data table

Erroneous readings in your data? Open up the data table for the web app and you can view it and edit the numbers and also delete rows.

03 Wire up the circuit

This is identical to the circuit we used in part two of this series. Place your Pico W on one end of a breadboard, as shown in **Figure 1**. With the power turned off, connect the DHT11 sensor to Pico W as in the diagram: power is supplied to its VCC by Pico W's 3V3 pin, GND is wired to GND, while the sensor's DOUT (digital out) pin is connected to GPIO 14 (you could use any GPIO pin).

04 Write the Pico code

Add the code from the `weather_graphs.py` listing and save it to Pico. Note that this is very similar to the code we used in part two of this series. Instead of sending a text string for the web app to display, however, we'll send the individual temperature and humidity readings with:

```
return(temp, hum)
```

As before, the `import anvil.pico` line enables Pico W to connect to Anvil's servers (using an uplink key for the web app), while `import uasyncio as a` sets up an asynchronous scheduler for running concurrent functions. Before defining our sensor-reading function, `dht11read`, we add a decorator line and an 'async' prefix to make it callable from the Anvil web app.

```
@anvil.pico.callable_async
async def dht11read():
```

05 Design the web app

If you haven't done so already, visit **anvil.works** and sign up for a free account. Create a new blank app and select a theme – as previously, we're using the legacy Material Design.

Let's give our web app a title. From the right-hand Toolbox panel, drag a 'Display label – text' component over to the 'Drop title here' field at the top left of the blue bar in the main app panel. In the text field under Properties, enter 'Weather Data' or something similar.

06 Add two graphs

Next, we'll create two graphs: one for temperature, the other for humidity. Drag a Plot component from the Toolbox into the main app panel. Drag another one underneath it. Under Properties,

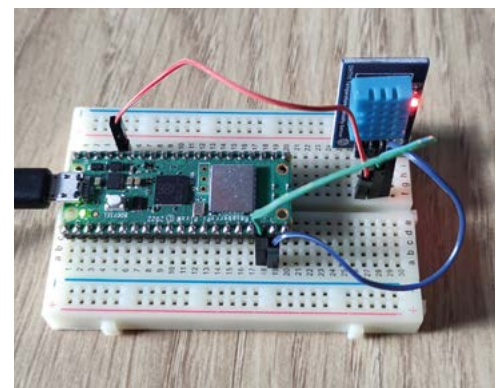

You'll Need

- Raspberry Pi Pico W
- Anvil account (free tier) **anvil.works**
- DHT11 sensor **magpi.cc/dht11**
- 3 × male-male jumper wires

▼ The DHT11 sensor measures both temperature and relative humidity

▶ When the Pico W code is running, the web app graphs will be updated with live data



rename them 'plot_temp' and 'plot_hum'; the names will automatically have a 'self.' prefix added. To add labels for the graphs and labels for their x and y axes, we'll need to add some code. Click on the Code tab and, under '# Any code you write here will run when the form opens', add the following code, making sure it's indented to the same level:

```
self.plot_temp.layout.title = 'Temperature'
self.plot_hum.layout.title = 'Humidity'
self.plot_temp.layout.xaxis.title = 'Time'
self.plot_hum.layout.xaxis.title = 'Time'
self.plot_temp.layout.yaxis.title = 'Temperature (°C)'
self.plot_hum.layout.yaxis.title = 'Humidity (%)'
```

If you try running the web app now, you'll see that the graphs have labels. Now stop it running.

Top Tip

Schema conflict

While editing your data table or app, you may see an error message saying that the default database schema doesn't match your app. Just click on the correct schema option to resolve it.

07 Create a data table

To plot data on our graphs, we will need to create a data table with three columns: for the date/time, temperature, and humidity. Select Data

time	temp	hum
01 Nov 2022, 19:58:26.2210...	25	60
01 Nov 2022, 19:58:30.457...	24	60
01 Nov 2022, 19:58:40.385...	24	60
01 Nov 2022, 19:58:50.5410...	25	61
01 Nov 2022, 19:58:50.427...	24	61
01 Nov 2022, 19:59:00.1620...	24	62
01 Nov 2022, 19:59:10.3990...	24	63
01 Nov 2022, 19:58:00.243...	25	64
01 Nov 2022, 19:59:20.0270...	23	64
01 Nov 2022, 19:59:30.878...	23	64
01 Nov 2022, 19:59:42.1920...	23	65

from the left sidebar and then '+ Add Table'. In the 'Python name' field on the right, change its name to 'weather_table'.

Click '+ New Column' and choose 'Data and time column'; we'll name it 'time'. Click the '+' button to the right of it and select 'Number column'; name it 'temp'. Click the '+' button to the right of that, select 'Number column' again, and name it 'hum'.

We now have our data table, into which we'll later write data sent from our DHT11 sensor connected to Pico. To make sure it can do that, set the table's 'Forms' Permissions to 'Can search, edit and delete' – otherwise you'll get a 'permission denied' error when running the web app.

08 Send table data to plots

The next step is to link our new data table to the graphs in our web app, so that they will plot the data from it – once there is any sent from Pico. Click the 'Form1' tab to return to the web app design, then click the Code tab.

We'll create an `update_graph` function to read each row of each the data and plot it in each graph. Add the following lines, indented by two spaces to match that of `def __init__`.

```
def update_graph(self):
    with server.no_loading_indicator:
        data = app_tables.weather_table.
        search()
        self.plot_temp.data = go.Scatter(
            x=[r['time'] for r in data],
            y=[r['temp'] for r in data],
        )
        self.plot_hum.data = go.Scatter(
            x=[r['time'] for r in data],
            y=[r['hum'] for r in data],
        )
```

To run this function and draw the graphs upon starting the web app, we need to add a line to the end of the `__init__` function (under `self.plot_hum.layout.yaxis.title = 'Humidity (%)'`), to call it:

```
self.update_graph()
```

09 Add a timer

As in part two of this series, we'll add a timer function to tell Pico W to run a function to send the DHT11 sensor data. Click the Form tab. In the

Toolbox panel, click 'See more components' and then drag a Timer component, so won't show on the finished dashboard. In the Properties panel, change the timer's Interval value to 10 (seconds).

Double-click the Timer component to show its default function in the code in Split view. Before **pass**, add the following code (indented to the same level):

```
data = anvil.server.call_s("dht11read")
app_tables.weather_table.add_row(
    time=datetime.now(),
    temp=data[0],
    hum=data[1]
)
self.update_graph()
```

The first line calls the `dht11read` function in our Pico W code, causing it to take a sensor reading and send the data. The next part adds a row of data with the timestamp and the temperature and humidity readings sent from Pico (to match the order in which we return them in the MicroPython code). To use the `datetime` method, we'll need to import it; in Code view, scroll to the top and add the following line (under `from anvil.tables import app_tables`):

```
from datetime import datetime
```

10 Enable server uplink

To link the web app to the Pico W program, click the '+' button at the bottom left and select Uplink, then click Enable Server Uplink. This will

▼ Enable Server Uplink for your web app and then copy the key to paste into your Pico W program

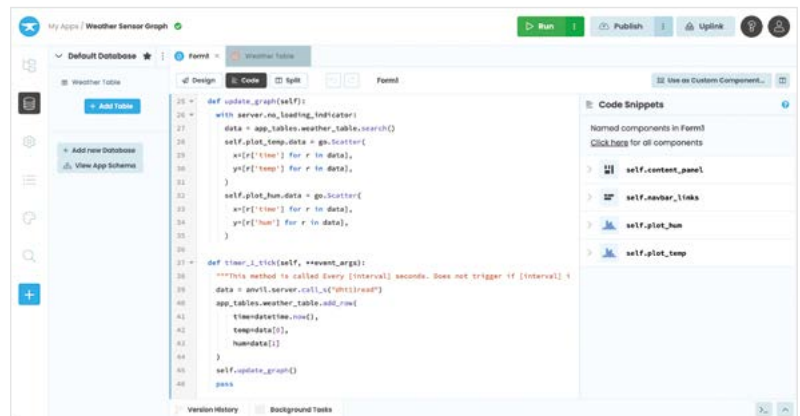
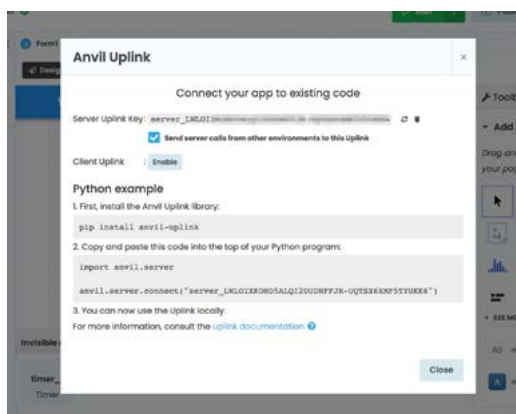

generate a Server Uplink Key for the app which you should paste into line 6 of your `weather_graphs.py` MicroPython code on Pico W so it can connect to it.

▲ The web app code include functions to read the data table and call the Pico sensor-reading function at regular intervals

11 Run both apps

First, run your Pico W program in Thonny. You'll see messages in the Shell pane to show it connecting. Once it has, run your Anvil web app (in maximised mode). You should now see the two graphs and it will start plotting data.

To extend or adapt the project, you could add different sensors to your Pico circuit and plot their data in graphs. [\[11\]](#)

weather_graphs.py

DOWNLOAD THE FULL CODE:
 magpi.cc/github

► Language: **MicroPython**

```
001. import anvil.pico
002. import uasyncio as a
003. import dht
004. from machine import Pin
005.
006. UPLINK_KEY = "<put your Uplink key here>"
007.
008. sensor = dht.DHT11(Pin(14))
009.
010. @anvil.pico.callable_async
011. async def dht11read():
012.     sensor.measure()
013.     temp = sensor.temperature()
014.     hum = sensor.humidity()
015.     return(temp, hum)
016.
017. # Connect the Anvil Uplink. In MicroPython, this call will
    block forever.
018. anvil.pico.connect(UPLINK_KEY)
```

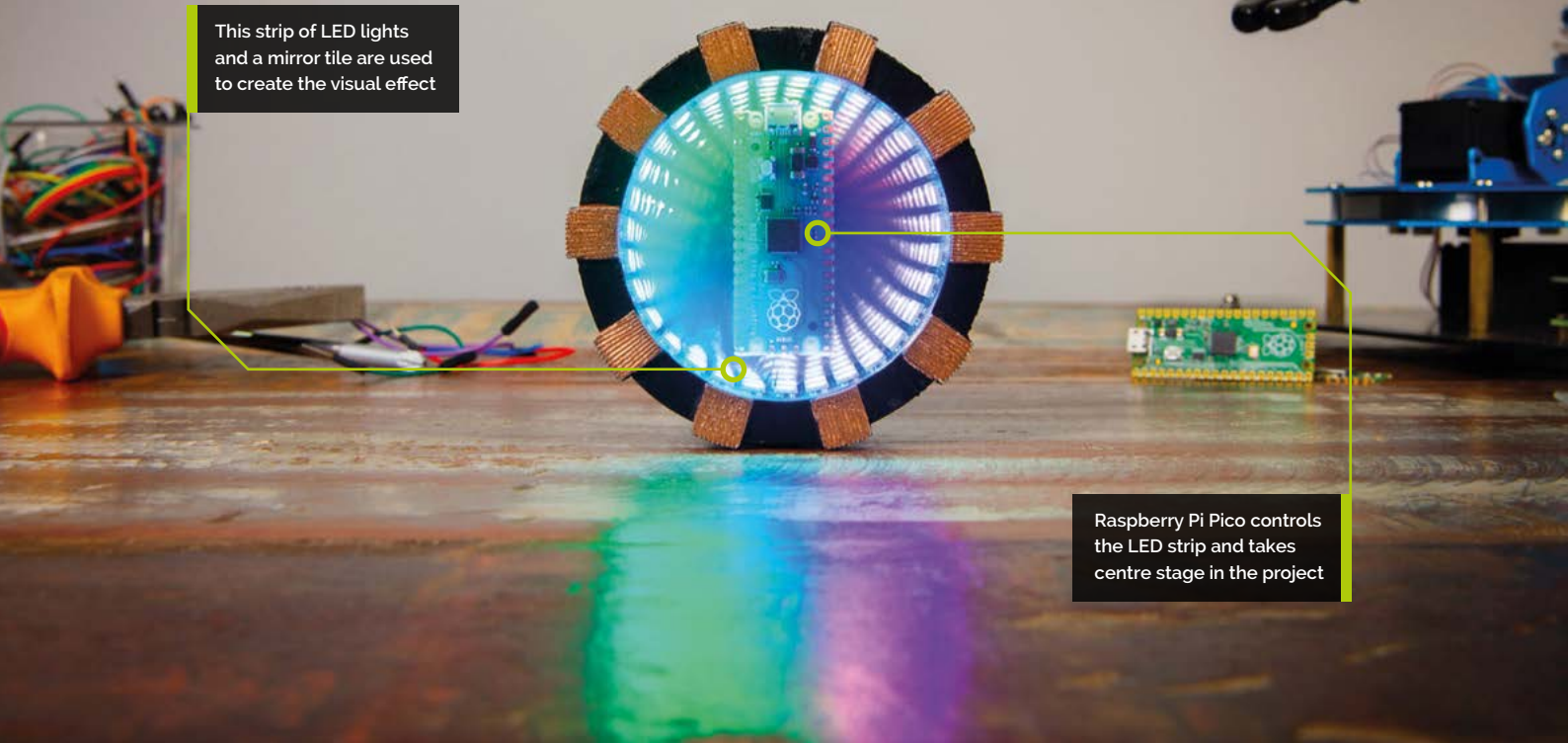

This strip of LED lights and a mirror tile are used to create the visual effect

Raspberry Pi Pico controls the LED strip and takes centre stage in the project

Raspberry Pi Pico

Iron Man Arc Reactor



Toby Roberts

Raspberry Pi Maker
in Residence.

raspberrypi.com

Build your very own Arc Reactor prop from Iron Man using LED lights

If you enjoy Raspberry Pi-based DIY build projects, there's a good chance that Iron Man might just be one of your favourite superhero characters. A billionaire inventor who created a suit of armour powered by a small, powerful electric generator known as an Arc Reactor — what's not to like? We're going to build our own Arc Reactor using a strip of LEDs and some wizardry to produce a 3D infinity mirror effect.

adhesive mirror sheet and the other will have a one-way mirror film; this will give the LEDs a 3D infinity effect. Unfortunately, we haven't yet perfected our own plasma fusion power source for Raspberry Pi, so instead, we will use a rechargeable battery and enclose everything in a 3D-printed case.

01 How does it work?

In this tutorial, we'll use a Raspberry Pi Pico to control 31 individually addressable LED lights mounted between two discs of acrylic plastic. One of those discs will have a layer of

02 MicroPython

Raspberry Pi has extensive documentation for Raspberry Pi Pico (magpi.cc/picodocs), but in this first step we will flash the Pico with firmware using the incredibly user-friendly, drag-and-drop method to transfer files to it (just as you would transfer files to a USB memory stick).

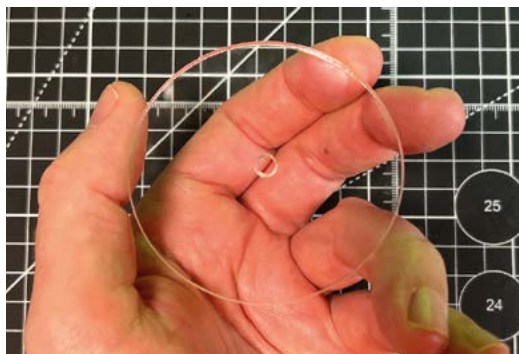

▲ **Figure 1** These acrylic discs can be created using a laser cutter, or cut manually using a jigsaw and sanding paper

On your computer, download the UF2 file for the latest release of the Pico MicroPython firmware from here. The MicroPython programming language is an implementation of Python that's optimised for use with microcontrollers, and it's considered to be one of the best languages for programmers of all levels of experience.

“ Using a strip of LEDs and some wizardry to produce a 3D infinity mirror effect ”

03 Installing the firmware

To copy the UF2 file you've just downloaded over to your Pico, you'll need first to put it into bootloader mode. To do this, hold down the BOOTSEL button (the small button next to the USB port) while simultaneously plugging a micro USB cable connected to your Pico into your computer. Your Pico should now show up as a drive called 'RPI-RP2:'.

Locate the .uf2 firmware file that you just downloaded, and drag and drop it into the RPI-RP2 drive, or simply copy and paste it over. Your Pico will now reboot automatically. Once you've done this, your Pico won't show up as a drive again when it's plugged in, but keep it connected ready for the next step. That's all there is to it – you've flashed the firmware.

04 Programming your Pico

Download, install, and open Thonny (magpi.cc/thonny), a Python IDE (integrated development environment). It's the software you'll

use on your computer to program your Pico when it is connected via USB.

If you see >>> in the Shell window, then you're already connected to your Pico and have an interactive session enabled, and you're ready to move on to programming your Pico. If you don't see this, you need to check that Thonny is set up correctly. Click on the very bottom-right corner of the Thonny window to make sure that the MicroPython (Raspberry Pi Pico) interpreter is selected; if it isn't, select it. If for some reason you weren't successful in flashing the firmware, Thonny may prompt you to install it at this stage; in this case, try flashing it again. If your Pico is still not showing up as connected, disconnect and reconnect it, then press the red STOP sign in Thonny's top menu bar to reset everything. You should now see the >>> prompt in the Shell window, meaning you're connected and ready to continue.

Now you're ready to program your Pico. Enter the code from **main.py** (overleaf). Or copy and paste the code from magpi.cc/arcreactor into the empty, and currently untitled, Thonny program window.

05 Read the code

One of the advantages of using MicroPython is that much of it is written in readable English. For example, at the beginning of this program, we can see that Pico will control 31 LEDs via pin 28, and that they are to be set at maximum brightness (1 on a 0-1 scale, 0.5 being 50% brightness). The rest of the program instructs your Pico to display patterns and colours on the LEDs repeatedly.



You'll Need

- ▶ Raspberry Pi Pico magpi.cc/pico
- ▶ WS2812B strip magpi.cc/ledstrip
- ▶ 3 mm-thick acrylic sheet, sufficient to cut 2 × 70 mm discs
- ▶ Self-adhesive flexible mirror tile sheet (not glass)
- ▶ One-way mirror self-adhesive film (the type used as sun-blocking window stickers)
- ▶ USB-C 5V 1A TP4506 charging board for 18650 lithium battery (or micro USB equivalent)
- ▶ Rechargeable 3.7V 1100mAh 603449 lithium-ion battery
- ▶ 2-position 3P SPDT panel-mount micro slide toggle switch, latching
- ▶ Approx 100 cm of 26AWG silicone stranded copper wire (or similar)
- ▶ Quick-drying superglue
- ▶ 3D-printed enclosure parts (STL design files available for free from Printables) magpi.cc/arcreactorstl

◀ **Figure 2** Soldering the electronics into the USB charging board

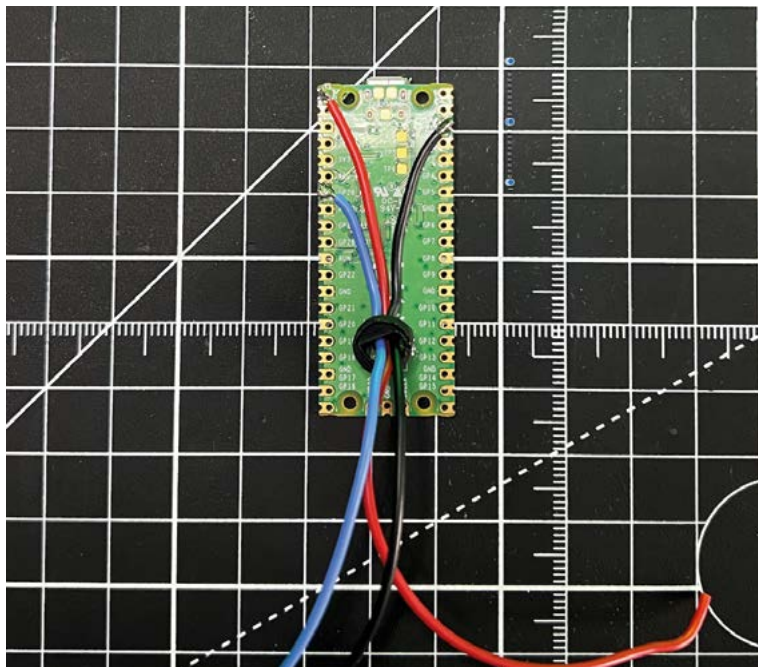

▲ **Figure 3** Soldering the wires to Raspberry Pi Pico. Pico is shown here with the wires threaded through the 3D-printed stand

Click on File and Save as... and a pop-up will appear prompting you to specify where you want to save the file. Click on Raspberry Pi Pico and name the file 'main.py'.

It's important to name the file **main.py** because any file with this name will be started automatically every time Pico is powered on. That's all there is to it: you've programmed your Pico.

06 The 3D-printed parts

Four 3D-printed pieces are required to house all the component parts: the back, main body, Pico stand, and front. We will simply glue them together to form the complete assembly. You can download the 3D print files free from Printables (magpi.cc/arcreactorstl). Print them using any FDM (fused deposition modelling) 3D printer with a build area of 70 mm² or larger; we recommend you use a material that is easy to print with, such as PLA or PETG filament.

07 Cutting and preparing the acrylic discs

For this project, we will need two acrylic discs 3 mm thick and 70 mm in diameter, one of which will require a hole approximately 5 mm in diameter for

wiring. If you have access to a laser cutter, making these is straightforward. Otherwise, it might be time to dig out your old pencil case and find a pair of compasses. Using a jigsaw, cut out a 70 mm circle, and neaten up the edges with sandpaper or a file. The final discs don't need to be absolutely flawless, since the subsequent steps will cover any minor imperfections. One disc should be drilled with a 5 mm hole in the centre to allow wiring to pass through later (see **Figure 1**).

08 Prepare the mirror

Mark a 70 mm circle on your flexible adhesive mirror tile, and another on your one-way mirror self-adhesive film. It should be fairly easy to get them perfectly round by cutting them out using scissors. Ensure that you remove all the protective layers from your acrylic discs, and then peel the adhesive backing from your mirror sheets in turn. Attach the circle of the mirror tile sheet to the disc with the hole, which will be used to mount your Pico, and the circle of one-way mirror film to the other disc.

“ Attach the circle of the mirror tile sheet to the disc with the hole ”

09 Wiring and soldering the electronics

The Arc Reactor base will contain the rechargeable battery, on/off switch, and USB-C charging board, all of which you need to glue into place inside the 3D-printed cutouts. At this stage, you need to do some cutting of wires, stripping, and soldering. Use **Figure 2** as a reference to ensure that the positive and negative wires from the battery are soldered to the correct USB-C charging board positive and negative inputs and that the positive output from the board is soldered to the centre pin

Top Tip

YouTube Video

Take a look at the Arc Reactor video on YouTube to see how it all works: magpi.cc/arcreactortyt.



Warning!
CNC Cutter

Be careful when using CNC cutters in your projects. Wear ear protection and safety glasses and stand clear of the machinery as it works. Understand the basic safety functions of your machine.

magpi.cc/cncsafety

main.py

> Language: Python

DOWNLOAD
THE FULL CODE:



magpi.cc/arcreactor

```

001. import array, time
002. from machine import Pin
003. import rp2
004.
005. # Configure the number of WS2812 LEDs.
006. NUM_LEDS = 31
007. PIN_NUM = 28
008. brightness = 1
009.
010. @rp2.asm_pio(sideset_init=rp2.PIO.OUT_LOW,
out_shiftdir=rp2.PIO.SHIFT_LEFT, autopull=True,
pull_thresh=24)
011. def ws2812():
012.     T1 = 2
013.     T2 = 5
014.     T3 = 3
015.     wrap_target()
016.     label("bitloop")
017.     out(x, 1) .side(0) [T3 - 1]
018.     jmp(not_x, "do_zero") .side(1) [T1 - 1]
019.     jmp("bitloop") .side(1) [T2 - 1]
020.     label("do_zero")
021.     nop() .side(0) [T2 - 1]
022.     wrap()
023.
024. # Create the StateMachine with the ws2812 program,
outputting on pin
025. sm = rp2.StateMachine(0, ws2812, freq=8_000_000,
sideset_base=Pin(PIN_NUM))
026.
027. # Start the StateMachine, it will wait for data on its
FIFO.
028. sm.active(1)
029.
030. # Display a pattern on the LEDs via an array of LED RGB
values.
031. ar = array.array("I", [0 for _ in range(NUM_LEDS)])
032.
033. #####
#####
034. def pixels_show():
035.     dimmer_ar = array.array("I", [0 for _ in range(
NUM_LEDS)])
036.     for i,c in enumerate(ar):
037.         r = int(((c >> 8) & 0xFF) * brightness)
038.         g = int(((c >> 16) & 0xFF) * brightness)
039.         b = int((c & 0xFF) * brightness)
040.         dimmer_ar[i] = (g<<16) + (r<<8) + b
041.     sm.put(dimmer_ar, 8)
042.     time.sleep_ms(10)
043.
044. def pixels_set(i, color):
045.     ar[i] = (color[1]<<16) + (color[0]<<8) + color[2]
046.
047. def pixels_fill(color):
048.     for i in range(len(ar)):
049.         pixels_set(i, color)
050.
051. def color_chase(color, wait):
052.     for i in range(NUM_LEDS):
053.         pixels_set(i, color)
054.         time.sleep(wait)
055.         pixels_show()
056.     time.sleep(0.2)
057.
058. def wheel(pos):
059.     # Input a value 0 to 255 to get a color value.
060.     # The colours are a transition r - g - b - back to r.
061.     if pos < 0 or pos > 255:
062.         return (0, 0, 0)
063.     if pos < 85:
064.         return (255 - pos * 3, pos * 3, 0)
065.     if pos < 170:
066.         pos -= 85
067.         return (0, 255 - pos * 3, pos * 3)
068.     pos -= 170
069.     return (pos * 3, 0, 255 - pos * 3)
070.
071. def rainbow_cycle(wait):
072.     for j in range(255):
073.         for i in range(NUM_LEDS):
074.             rc_index = (i * 256 // NUM_LEDS) + j
075.             pixels_set(i, wheel(rc_index & 255))
076.             pixels_show()
077.             time.sleep(wait)
078.
079. BLACK = (0, 0, 0)
080. RED = (255, 0, 0)
081. YELLOW = (255, 150, 0)
082. GREEN = (0, 255, 0)
083. CYAN = (0, 255, 255)
084. BLUE = (0, 0, 255)
085. PURPLE = (180, 0, 255)
086. WHITE = (255, 255, 255)
087. COLORS = (
BLACK, RED, YELLOW, GREEN, CYAN, BLUE, PURPLE, WHITE)
088.
089. while True:
090.
091.     print("fills")
092.     for color in COLORS:
093.         pixels_fill(color)
094.         pixels_show()
095.         time.sleep(0.2)
096.
097.     print("chases")
098.     for color in COLORS:
099.         color_chase(color, 0.01)
100.
101.     print("rainbow")
102.     rainbow_cycle(0)

```

of the sliding switch. The positive wire from the switch can be soldered to either of the two outer switch terminals.

10 Solder to Pico

The next step is to solder three wires directly to the back of your Pico. The wires should be long enough to complete the wiring circuit later in the assembly process: approximately 20 cm should be sufficient. In order to provide power to Pico, you need to connect red and black wires to the pins marked VBUS and GND respectively. We need a third wire, shown in blue in **Figure 3**, that you should solder to the pin marked GP28. Our MicroPython script specifies this as the pin used by Pico to communicate with the LEDs.

11 Wiring loom

LED strips are usually pre-wired, but their joints are often bulky, so we will make our own wiring loom. Using a pair of scissors, remove any pre-existing wiring and cut a strip of 31 LEDs, making sure to cut along the line between each LED (see **Figure 4**).

The strip is also marked with arrows to show the correct current direction, + symbols for the positive wire, o for the data wire, and G for the negative wire,

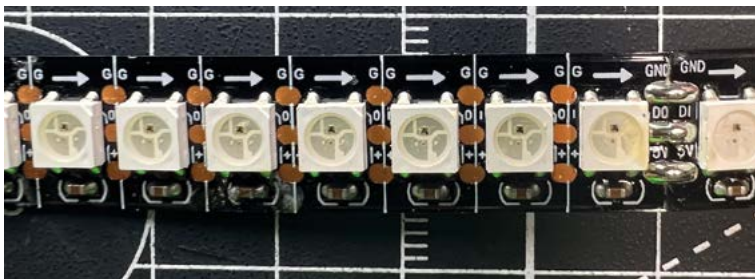

▲ **Figure 4** Cutting the LED strip down to the right size

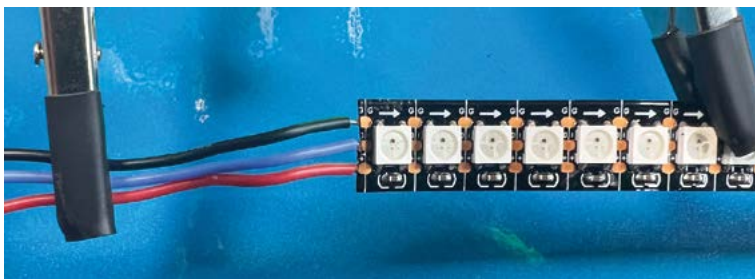

▲ **Figure 5** Soldering the wires onto the LED strip

Top Tip



Test, then glue

Don't forget to test everything works before gluing it all together.

or ground wire. It's important, when cutting, to make sure that you snip down the middle of each solder pad; if you're not careful, it makes it tricky to solder the wires to the pads.

12 Solder more wires

Solder three more wires, also approximately 20 cm in length, as shown in **Figure 5**: red for positive, blue for data, and black for ground. When soldering to the pads, you may find it more convenient to do so from the rear of the strip.

“ Ensure that Pico sits above the surface of the mirror on the stand ”

13 Assembly

Feed the three wires attached to your Raspberry Pi Pico through the small 3D-printed Pico stand. Then thread the wires through the hole in the mirrored disc, and glue the stand to the underside of your Pico and to the reflective side of the disc. Ensure that Pico sits above the surface of the mirror on the stand. In doing so, we will achieve our goal of a 3D infinity effect (see **Figure 6**).

14 Glue and stick

Now, place the disc with the one-way film in the main 3D-printed body and glue the front ring to the body. Because the disc is held in place by the front ring, any minor imperfections in its shape will be concealed.

Stick the strip of 31 LEDs around the inside of the 3D-printed body, ensuring that the wiring and connections are aligned with the gap in the body, so that you can easily pass the wires around the side of the disc on which your Pico is mounted.

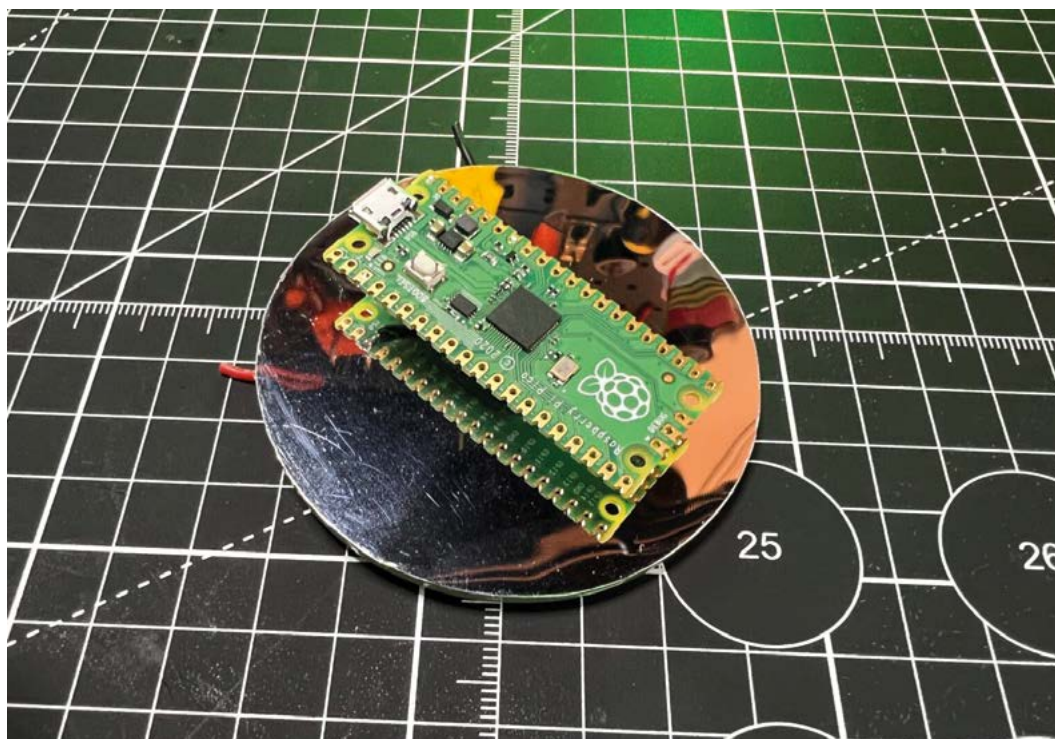

◀ **Figure 6** Attaching the Raspberry Pi to the mirror disc with glue

▼ **Figure 7** How everything fits together

Most LED strips have a self-adhesive backing, which helps make this straightforward. Refer to the diagram in **Figure 7** to see how everything will fit together.

15 Solder it all together

With Pico already glued to its mirrored disc, you can now pair it with the main body housing the LEDs and the one-way mirror, and with the base containing the battery, charging board, and switch. Make sure that you have the ends of all your wires threaded through to the Arc Reactor base. Solder the two blue data wires together, all three red positive wires together, and all three negative ground wires together, trimming any excess wire length as necessary. Don't forget to insulate your joins with heat-shrink tubing or tape.

16 Final checks

Before you glue the pieces together and make it final, check that everything is working as expected and that your LEDs are lighting up by sliding the switch. Make sure the charging board functions by attaching a USB-C phone charger or a USB battery pack; a small LED will illuminate when it's charging.

Now all that's left to do is to glue all the parts together. [\[11\]](#)

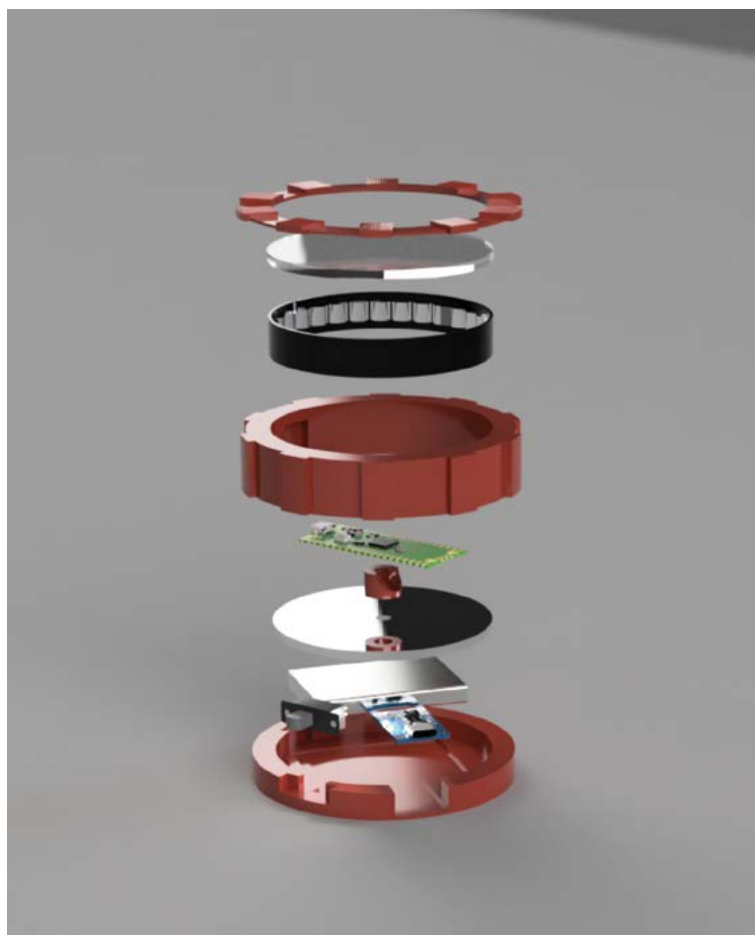

HOW

By **Brendan Charles**

I

MADE

Computers used to be enormous machines the size of entire rooms, made exclusively for governments and industry.

Then they became small enough to serve as fixtures inside the home. Eventually, somewhere in the 1980s, they were small enough to become portable devices that you could take with you nearly anywhere. At this point, the possibilities of productivity and creativity were practically limitless. It's this feeling of limitless potential and portability that inspired me to create my portable PC project.

Taking some mid-1980s portables as a point of inspiration, I looked at two specific models: the Dynamac and the Grid Compass. Both have a certain sense of rarity and mystique to them (the Dynamac being a limited release Macintosh conversion, and the Compass being the computer of choice for NASA engineers). The two models were also aesthetically pleasing in both opened and closed positions.

I originally wanted to use an old PC case for the body of my computer, but quickly realised that, with the price collectors pay for

CERES-1 PORTABLE

A retro-inspired laptop



these relics, it wasn't going to fit my budget. So, I started looking at retro toy computers instead. Luckily, I discovered the Talking Whiz Kid made by VTech in 1987. It looked like an old computer, had plenty of room to fit a small screen, a Raspberry Pi, and other components and, even better, it was only about 30 bucks. So I bought the one in the best condition for the best price, and moved on with my project.

While I waited for the body to ship, I began making mock-ups in SketchUp. I got measurements of the body online, and started to plan where the components were going to go. There was a lot of guesswork at this stage, but I was comfortable enough to commit to a 7-inch screen made by GeekPi for the display. I also bought a

compact keyboard (for an iPad case) that I thought might fit into the body of the PC.

When I finally received the Talking Whiz Kid, it felt like Christmas morning. The first thing I did was open it up and (carefully) take out all the original components. Then, I used a Dremel to cut out any plastic pieces or parts that weren't needed any more. This gave me a better idea of how much room I had for all my parts, and the exact size I had to work with. I had two big revelations at this point: first, that I could use the original VTech speaker if I got an amplifier board for my Raspberry Pi, and second, the iPad →

Above ↕
The donor machine: a 1980s toy computer

**“THE FIRST THING I DID WAS
OPEN IT UP AND TAKE OUT ALL
THE ORIGINAL COMPONENTS”**

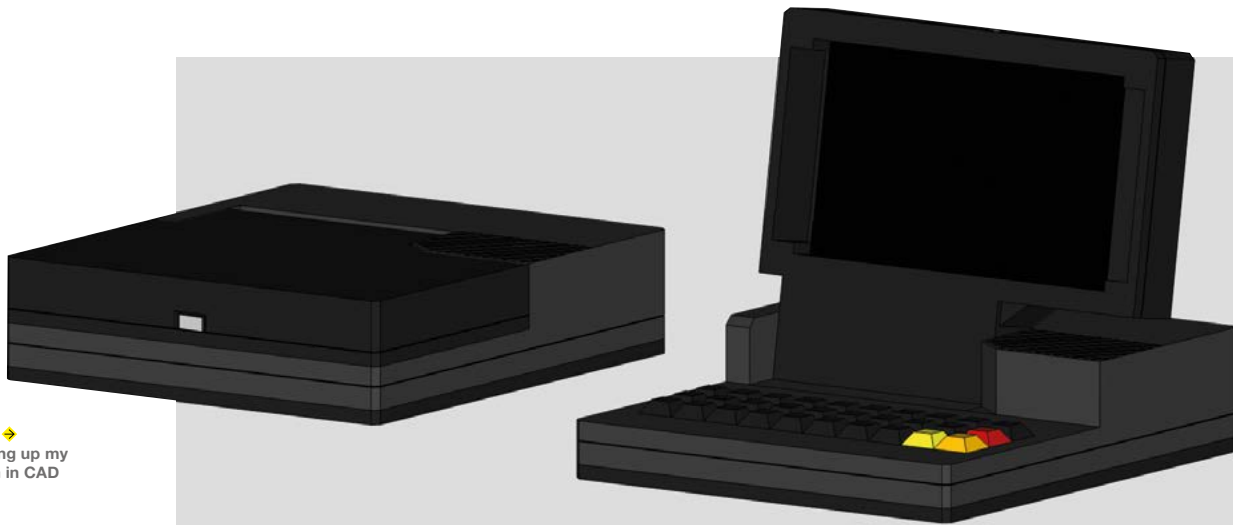

Right ↗
Mocking up my design in CAD

keyboard I bought was not going to work. If I wanted to plug the keyboard in while using it, the wire was going to stick out awkwardly from the side and would be too large for the case.

I now ran into my first major blocker of the project: the keyboard. I spent months looking for the perfect keyboard to fit inside this small case, and finally came to one daunting conclusion: I was going to have to make a custom mechanical keyboard. Having never soldered anything in my life, this was an intimidating prospect, but was looking like the best option. The smallest keyboard I found was a PB Gherkin, a tiny 30-key kit that fit perfectly in my case. I also had to buy an inexpensive soldering iron to get the job done.

To construct the Gherkin, I had to solder diodes, key switches, and a microcontroller

onto a PCB. I must have made every mistake you could possibly make. I soldered diodes in the wrong direction, installed the microcontroller upside-down, and bridged a couple of switch pins. Eventually, I was able to troubleshoot all these issues away and, along the way, learned even more soldering skills, like applying flux and desoldering using a sucker. I also came to the realisation that, if the keyboard was going to fit, I was going to need to add a layer of Plexiglas to the bottom of the case and then drop the keyboard into it. Otherwise, the keyboard would be too high and the top of the case wouldn't close. After all this work, I had made a fully functioning mechanical keyboard, complete with custom keystrokes and macros to account for the small size.

My second biggest obstacle for the project was the battery and power system. Not being an electrical engineer, some of the inner workings of power draws, currents, and amperage were lost on me, and probably still are. However, using the many resources online, I was able to learn that I was going to need a few things to make this setup work: a battery with a high enough capacity to run the PC for a couple hours, a power boost module to provide a stable enough current at the right amperage, and good wires to connect everything together. Since my Raspberry Pi would be powering a screen, keyboard, audio amplifier, and small fan, it was really important to get the most

Below ↓
Keyboards aren't complex, but do involve a lot of soldering





HackSpace

This tutorial is from HackSpace magazine. Each issue includes a huge variety of maker projects inside and outside of the sphere of Raspberry Pi, and also has amazing tutorials. Find out more at hsmag.cc.

Left ←

The new keyboard and screen in place



power from my battery as possible. I learned most of this information from Adafruit and their many guides, and ended up buying the battery and wires directly from them. I purchased the power boost module from another manufacturer called DFRobot, which was able to supply a little more power to my build. After a bunch of trial runs and refunding wires for slightly better ones, I finally got my entire setup to work solely off battery power.

As I progressed through the build and started using the keyboard more for trial runs, I realised I could do a whole lot better. Even though I practically pulled my hair out trying to figure out my Gherkin, the experience I got from building it made me realise there were other, better options. So, I went back to the chalkboard and found another keyboard that worked even better.

The 5x5 keyboard was a modular project that allows you to connect PCBs of five keys by five keys together, to make a configuration of 5x5, 5x10, or 5x15. So I

chose to make a 5x10, but had to leave the top row of keys empty in order for everything to fit in my case.

After already having one under my belt, the second was much easier to assemble than the first. Though I'll admit it was not without its own challenges. This keyboard,

**“I MUST HAVE
MADE EVERY
MISTAKE”**

for example, used a different microcontroller (an Arduino Micro) which was slightly more difficult to get working than the last one (a Teensy). When the keyboard was finally complete, it fitted into the case much better, and I had an extra row of keys for the numbers at the top.

As I was going down the checklist of features I wanted in the build, only one thing was missing: I wanted to add a built-in →



Above ↗
The internals before gutting



Left ↩
Paint hides a multitude of sins

to complete the project. So, unfortunately, I had to settle on using a Bluetooth wireless mouse when in the Raspberry Pi OS.

Now that I had solidified my complete setup, I dry-fitted my components into the case to confirm that everything worked properly. With the help of my 3D printer, I made some brackets to fit the display into, a clip for the ribbon cable, and a front panel for the top of the case to leave room for the keyboard and hold down the screen. It was pretty satisfying to see everything working and enclosed in the body of the PC that I'd spent many months cutting and cramming parts into.

The last major step in the completion of my portable PC was painting it. I uninstalled all my components once again and did a few coats of spray paint, sanding in between each layer. I ended the process with a couple of light coats of spray polyurethane to seal everything up and protect from stains and smudges.

Seeing my finished project boot up for the first time was a magical moment. There were some flaws in my execution of the build that stuck out to me, but probably weren't so noticeable to everyone else. The biggest issue was a small sealed-up hole on one side from where I was going to place the built-in trackball. On the whole though, I

cursor to the case. After doing some more research and ordering some more parts, I found two modules that might work: a ThinkPad-style trackpoint (red ball) and a trackball made by Pimoroni. While both made really good cursors when I tested them on a normal PC, I ran into problems using them with my Raspberry Pi. The problem seemed to be in my power distribution. Since my Raspberry Pi was already powering so many different things, it had reached its limit for what it could do with the battery. I might have been able to make it work if I upgraded the battery or power boost module but, if I'm being honest, I didn't have the know-how to pull it off, and I also really wanted

**“I FOUND TWO
MODULES THAT
MIGHT WORK”**



Right ↪
Old and new in one hybrid build

CERES-1 PORTABLE



Above ⬆️
A layer of varnish helps protect the finish

was very happy with the way it turned out. From this point on, I focused on the software. I installed the system to boot into RetroPie, where I also installed Kodi for media, and a short cut to the PIXEL desktop environment for coding and word processing.

For a while, I didn't know what to name my portable computer, except I knew I wanted it to have a space-related name. So, I started looking at celestial bodies and stopped on Ceres, a dwarf planet in our solar system. It's small, and so is my PC, and I liked the wordplay of Ceres-1 (instead of Series 1). So the Ceres-1 Portable was born, and I've been having fun with it ever since.

A fun coincidence happened after I posted my creation online – I received a comment from someone asking if my project had anything to do with the Ceres Workstation,

which, with a little research, I discovered was an existing line of computers made by ETH Zurich in 1987. While I wasn't aware of the existing models, the fact that these computers existed in the same era I drew inspiration from was kind of validating.

As happy as I was with the final product, I was even happier with all the skills I learned along the way. Prior to the project, I had never touched a soldering iron, made a custom keyboard, or dealt with many of the components that I used in this build. With the help of YouTube tutorials, message boards, and different Discord

servers, I was able to navigate my way through these unknowns and build myself a cool PC that not only worked, but brought back the nostalgic feeling of retro PCs that inspired me. □

Below ⬇️
All finished and looking new, well, old. You get the idea



CREATING A MAKER! ROOM!

BUILD A HAVEN FOR ALL THINGS
MAKING WITH THIS GUIDE
FROM **ROB ZWETSLOOT**

Having a workspace is a great thing. While dumping your project bits on the dining table has a degree of nostalgia, it becomes a bit of a pain when you need to clear away for dinner or your next game of Terraforming Mars.

If you're lucky enough to have a spare room, or even some spare space in a room, turning it into a den of making is very easy, and means you can have a lot more fun with building your projects.

Here's how you can transform a space into a makerspace.





STURDY DESK

For any kind of workshop or workspace bench or desk, you need to get something you don't mind damaging. It will happen, and you also don't want to be worrying about that if you're having to cut, paint, heat, or hammer something. Get one as large and as basic as possible to really get the most out of it.



+ BIN

Don't forget to get a bin and/or recycling container for your workspace.



STORAGE

Tools, components, nuts, bolts, materials, project parts – it's very satisfying to have these all ordered in the little drawer-style storage solutions, tool trays, drawers, etc. Plastic ones are pretty cheap and flexible in terms of where you put them.

ROOM SETUP

WHAT EVERY WORKSPACE NEEDS

There are many different kinds of making – whether you're working with electronics, wood, or cotton wool, there are some basic things you'll need to consider for your setup.

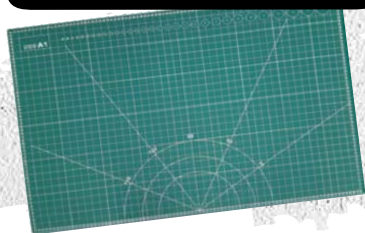

CUTTING MAT

Cutting mats are not only designed for you to cut on, but also have some useful measurements and angles and other data printed around them. Plus it can be a good way to centre your workspace.

COMPUTER

Is this obvious? It doesn't seem like it would be that obvious. We've seen makerspaces with monitors mounted on the wall at the back so that maximum real estate on the desk can be used.

A Raspberry Pi 4 or 400 can help power it for looking up guides, and even testing your projects.



WHITEBOARD

When you're thinking up ideas and solutions, it helps to have a note. A big whiteboard can also make you feel like you are doing some proper engineering as well.

+ VENTILATION

This is quite important, especially if you're soldering, gluing, and painting. An extraction fan and/or window is a good way to stay ventilated.

ELECTRONICS AND TOOLS

FILL YOUR BOOTS AND YOUR WALL PEGS WITH THESE TOOLS

GENERAL TOOLS

DRIVER SET

Have some kind of screw to tighten? Driver sets tend to come with a bit for every kind of screw, whether it's Phillips or hex. We like ones that come with a ratchet attachment as well, which allows for faster hand tightening. You can always pair it with a small electric screwdriver too.



POWER DRILL

If you need to make a hole cleanly and safely, you need a drill. Make sure you get some drill bits for different materials – and always stay safe.



KNIFE

A good craft and/or utility knife has many functions. Of course, it can cut thinner materials nice and smoothly, but they can also be useful for jimmying things open or shaving off imperfections in materials.



+ GET YOUR MATERIALS

PROTOTYPING WIRE



SOLDER



RESISTORS



LEDs



CARD



ELECTRONIC TOOLS

HELPING HANDS

From soldering to small details, helping hands easily allow you to set up clamped parts for joining or working on.



SOLDERING IRON



These are basically very hot pens that you use to heat up solder for joining wires to circuits. Get one from a reputable electronics website to make sure its of good quality. Follow this advice on how to set up your soldering iron: magpi.cc/soldering.

WIRE CUTTER



While you can use a good pair of scissors or a knife, a good wire cutter will also have a wire stripper, which is a tool for stripping the plastic casing off of wire. It's a bit cleaner than other methods.

MULTIMETER

When troubleshooting an electronic circuit, a multimeter can be used to make sure current is running – and running correctly – between two places. It's very handy.



GLUE GUN



Any well-stocked workspace will have many types of glue; however, a good hot glue gun is essential. Make sure to get one with at least two heat settings – a lower setting can be good for sealing something, or gluing between more fragile materials.

ROTARY TOOL



A useful multi-tool for all kinds of making, these have various kinds of sanding bits, drill bits, etc. which are great for fine detailing by hand.

HAMMER



Sometimes force is required in making – such as using nails or taking apart an old piece of very stubborn technology. Get one with a claw at the end in case you put a nail in the wrong place.



HEAT-SHRINK

HOT GLUE STICKS



SUPER GLUE



MARKER PENS



JUMPER WIRES



WHERE TO SHOP

- The Pi Hut: thepihut.com
- Pimoroni: pimoroni.com
- Adafruit: adafruit.com
- PiShop: pishop.ca

3D PRINTERS

THE FUTURE OF MAKER ROOMS IN THE PALM OF YOUR HANDS

Making circuits and using a Raspberry Pi for your projects is sometimes only part of the build equation. Sometimes you need something to put it in, and this is where woodworking, metalwork, or even LEGO can come in handy. Now, you can create even more customised cases thanks to 3D printing. Here's what you need to know.



CHECK OUT HACKSPACE MAGAZINE!

Our sibling publication HackSpace Magazine covers a wider variety of making tools and techniques, and we highly recommend giving it a read! hsmag.cc

FDM PRINTERS

What tends to be formally known as an FDM (fused deposition modelling) printer is your bog-standard heated plastic-extruding 3D printer. All 3D printers work in layers, depositing some material on a plate, and then adding a layer on top of that. You may have heard the term 'slicing' or 'slicer' used when 3D printing software is mentioned, and this is how 3D models are prepared for printing – it's sliced up into layers that the printer can replicate.

These kinds of printers are a great entry point into 3D printing, especially as budget versions enable anyone to get started with the hobby. This comes with some drawbacks, though – they require a lot more setup and maintenance than pricier printers, and you won't have such a large print bed. Consider your space and budget when buying them.



DESIGNING MODELS

3D printing comes under the category of CAD software, but you can also make use of more traditional 3D modelling software.

For simple geometrical designs, FreeCAD (freecadweb.org) makes it easy with plenty of simple tools that allow you to build up cases and so on quickly, with exact measurements.

For more complex models, Blender (blender.org) is a free 3D modelling tool that can output files as STLs for 3D printing, and includes traditional polygonal building, as well as Z-brush sculpting.



ESSENTIAL ADD-ONS AND ACCESSORIES



GOGGLES

Safety is important. When using rotary tools or any kind of cutting device, goggles can help stop shrapnel flying into your eyes. Plus, they make you look like a cool inventor when you wear them.

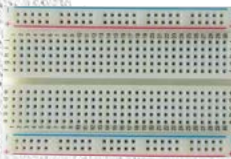

BREADBOARD

For prototyping circuits, breadboards allow you to quickly move components and wires around to make sure everything works before you start soldering that final circuit.

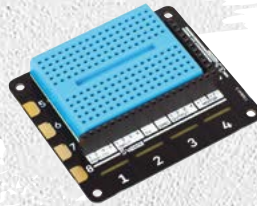

EXPLORER HAT PRO

There are several kinds of HATs like this that allow you to test out circuits with buttons and even connect to robots to make sure your code is working. The bigger they are, the more they can do, and can even be great for learning electronics. Get it at: magpi.cc/explorerhatpro.



SUGRU

Sugru is a kind of modelling putty that is also like glue, and is fantastic for temporary and even permanent fixings for projects. It also comes in multiple colours depending on what you need. Find out more at sugru.com.

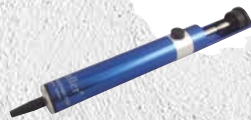

DE-SOLDERING PUMP

Also known as a solder suckers, these devices will immediately suck up hot solder for when you need to remove some from a circuit. They tend to come in a lot of soldering kits and are very useful when you need to make some corrections. 

RESIN PRINTERS

These style of printers use UV light to harden a liquid resin, again in layers, to create a print. This is much like an FDM printer; however, there are some major differences.

First of all, you can get a smoother print this way. Filing, sanding, and painting FDM prints is very time-consuming and while you still have to do some post-prep on a resin print, you don't need to do nearly as much.

The downsides to resin printing stack up, though. It requires the use of toxic chemicals, so ventilation is essential. It can also be much slower depending on your printer, and they tend to be much more expensive. Finally, initial clean-up of a fresh print can be messy.

+ FINDING 3D MODELS

3D printing has been around for a while now, and so there are a few communities that put out STL files that you can use yourself.

FREE
thingiverse.com
printables.com

PAID & FREE
etsy.com

Elecrow SH080 8-inch mini HDMI screen

SPECS

SCREEN SPECS:

8-inch LCD IPS display

16:10 aspect ratio

300 cd/m²

1280 × 800 pixels

speakers; mini HDMI input

5V / 2A USB power

280g

► Elecrow ► magpi.cc/sh080 ► £89 / \$89

Elecrow's companion display for Raspberry Pi, games consoles, and other devices leaves **Rosie Hattersley** confused

There are myriad reasons why you might want a vibrant display to use alongside your Raspberry Pi or other hardware. At 8 inches, and with a resolution of 1200 × 800 pixels, this £89 screen is good for a second laptop display with a spot of retro gaming on the side, and we imagine it will work well with other HDMI output devices such as microscopes. It means that a Raspberry Pi enthusiast, keen on keeping things compact, can stick with a miniaturised computing setup without having to squint to see on-screen items.

Elecrow's own website suggests using this screen with a Raspberry Pi for gaming. We tested the display alongside Elecrow's CrowPi L – itself a dedicated laptop hull that fits a full-size Raspberry Pi inside and which has an HDMI port. Rather unusually, the screen has a mini HDMI input. Powering the screen additionally requires a mini USB to mini USB cable. This is less out of the ordinary and, at least, means the screen can be entirely powered by the hardware to which it's

connected, rather than requiring an external power source and plug. One of the more useful inclusions is an adjustable metal stand that can be used to cradle and prop up the display. The three-bar stand is hinged making it easy to angle and support the screen however you please. For the Raspberry Pi 4/400 user without a CrowPi L or laptop setup, however, hooking up this screen will require an adapter: Raspberry Pi 4 has a pair of micro

HDMI ports, rather than the

Elecrow's HDMI to mini HDMI cable (with a mini HDMI port on the screen itself). These micro to mini adapters aren't common, and it would be

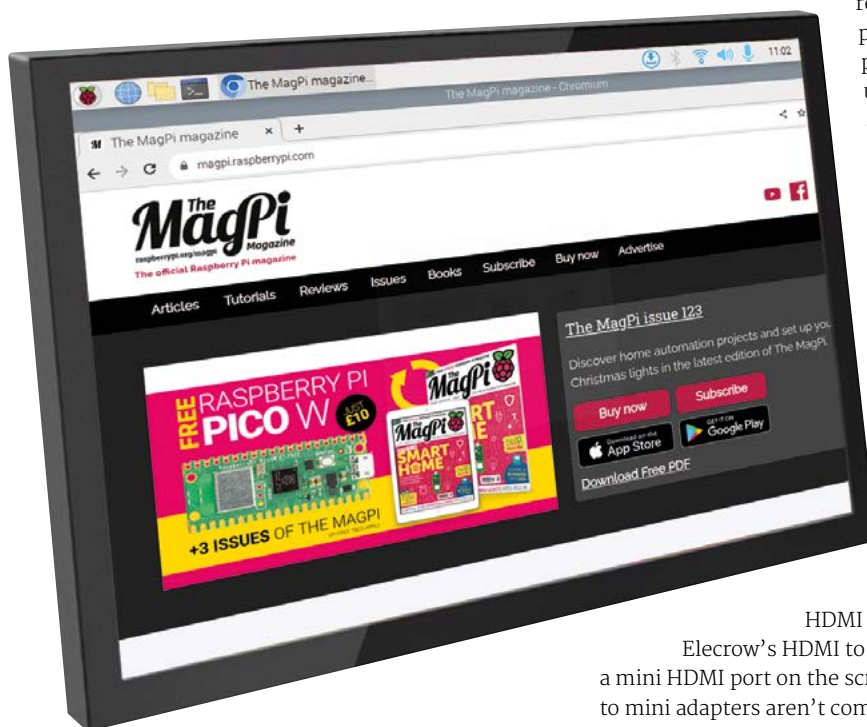

► Elecrow's vibrant 8-inch screen makes colours sing

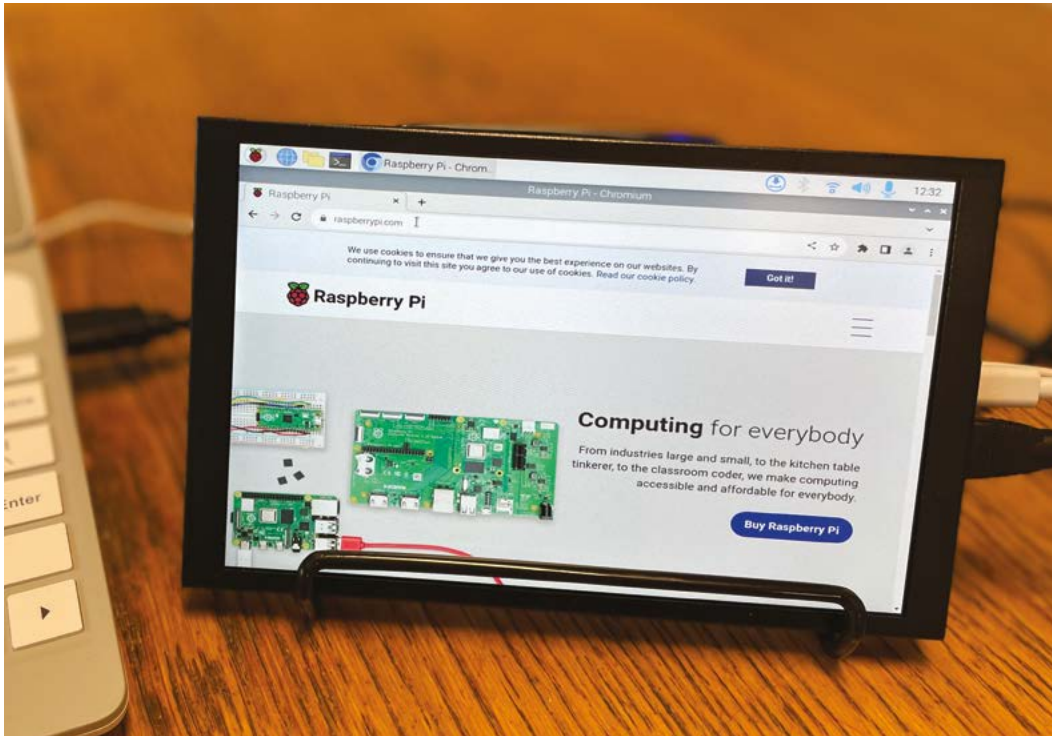

better if the screen itself had a more common full-size HDMI port.

There is no touch display on this option, so this screen can't be used to create small kiosk-style projects.

Using the screen

Display-wise, when used as a secondary screen, the Elecrow portable display shows whatever is on the desktop, including folders, files, and the waste basket, but useful items such as the menu bar are only shown on the primary device. The display is clear and crisp, even at lower resolution settings, with generous viewing angles. It's easy enough to switch between screens using the Appearance editor and Preferences drop-down menu in Raspberry Pi OS. Even if you do this, however, a web page you navigate to, for example, will display only on the other screen, even if you've specified that both monitors should show the same content and/or set the Elecrow as the primary display.

For entertainment duties, the maximum playback resolution of 1200 × 800 pixels combines with built-in speakers or an earphone socket. You'll need to specify HDMI output rather than headphones by right-clicking the volume icon on-screen. Speaker sound was rather patchy, but better using earphones. **M**

“ This £89 screen is good for a second laptop display with a spot of retro gaming on the side ”



▲ You will need an adapter or a Raspberry Pi with a full-size HDMI port if you want to use this screen with your Raspberry Pi

◀ It makes an ideal sidekick to laptop projects such as this CrowPi L

Verdict

A second screen is helpful in all sorts of instances, and Elecrow's portable version is clearly aimed at entertainment, what with its HDMI, speaker, and earphone connections. The mini HDMI connection and supplied full-size HDMI to mini HDMI cable mean you'll need an HDMI to micro HDMI adapter for Raspberry Pi 4. That makes this quality display less useful than its bright screen and decent resolution would suggest.

7 / 10

POP CAMERA

SPECS

DIMENSIONS:

70 mm × 57 mm
× 36 mm

CAMERAS:

2 × 8MP
sensors with
200-degree
angle lenses

COMPUTER:

Raspberry
Pi Compute
Module 4 with
2GB RAM and
16GB storage

VIDEO

OUTPUT:
360-degree
stereoscopic
fish-eye

► Villmer ► pop.company ► TBC

This 360-degree camera built upon Raspberry Pi Compute Module 4 brings VR recording to more people. **Rob Zwetsloot** enters the virtual reality to take it for a 360 spin

Virtual reality, while not exactly burgeoning technology, has not quite been adopted by everyone yet – largely due to the expense.

Headsets like the Meta Quest 2 have lowered the barrier to entry but, even then, widespread adoption hasn't happened.

Creating VR videos is another beast entirely. Regular cinematography rules don't apply and you need to be very careful so as not to make the viewer feel motion sickness. POP CAMERA immediately seeks to make this much easier with a 360-degree camera using two fish-eye lenses connected to a Raspberry Pi Compute Module, and an aim to make it as cheap as possible.

The version we received was pre-assembled; however, the assembly instructions are simple

and very well illustrated on the website – all you need to do is attach everything to the case and PCB and you're just about ready to go. You may notice that the website uses a lot of large UI elements; the website itself is based on the same interface as the POP CAMERA, and is optimised for ease of use on any system, including VR. For construction and initial setup you may prefer to use a desktop, or even a smartphone browser.

We asked the creator whether or not a more desktop optimised version would be made but, for now, they're trying to keep it simple. However, we actually found that it helped us get our head around the UI for POP CAMERA before we started to use it properly.

We are VR

It is perfectly usable from a desktop browser, though, which is how we mostly tested it out. Initial setup is fairly simple – you just need to log onto POP CAMERA via a hotspot access point and then input your Wi-Fi details. With any luck, you'll be able to connect via your browser by pointing at **popcamera.local**, but in the worst case you can just press the button that resets the Wi-Fi details to the hotspot.

From here, you can record, get a live preview, view your files, and download the video directly. You can also set up an account that allows you to upload files and even



► POP lives in a fairly unassuming white case

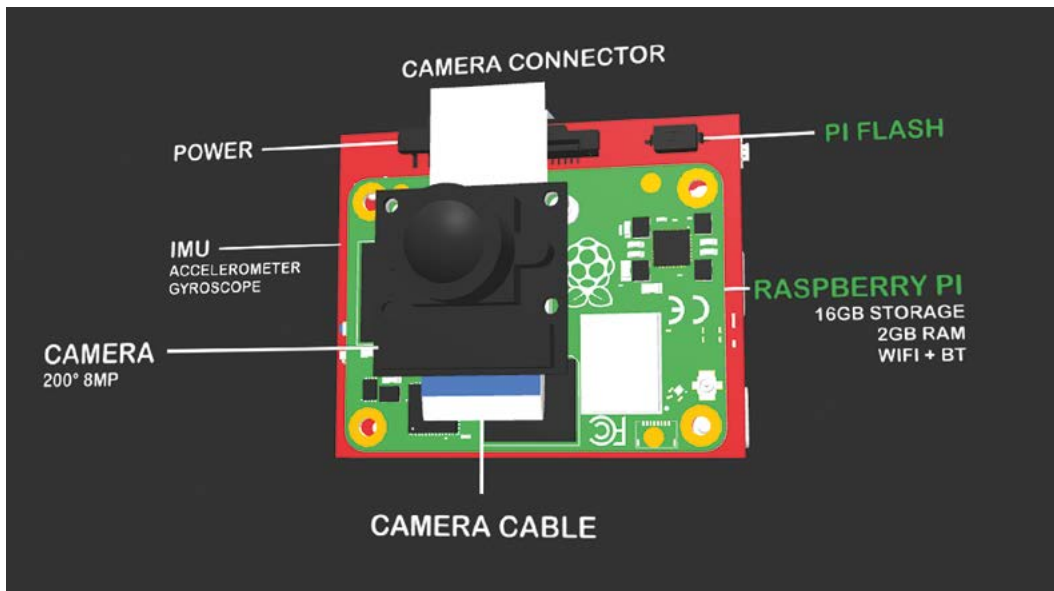

◀ An accelerometer allows videos to be kept stable and level

stream live. The live preview was fun to see when connected via a VR headset (we used the aforementioned Meta Quest 2), and recorded video downloaded to the device was easy to watch in 3D.

Reality barrier

While the hardware and UI is great, the quality of video leaves something to be desired. Audio is not binaural, which makes sense as there is only one mic, and the resolution and video is noticeably not as good as professionally made stuff. It's still very good, however, and it's understandable that the quality would be lower than others as it's using Raspberry Pi camera modules.

It is good enough, though, and the constant updates make it better all the time. We were

“ It is good enough, though, and the constant updates make it better all the time ”

surprised at the quality of objects placed up very close to the lens, and there is some auto-stabilisation and levelling that meant we didn't get a little disorientated either.

We're looking forward to putting it through its paces for some fun 360 videos in the future. **M**

▼ It also includes GPS so you can add location data to your videos

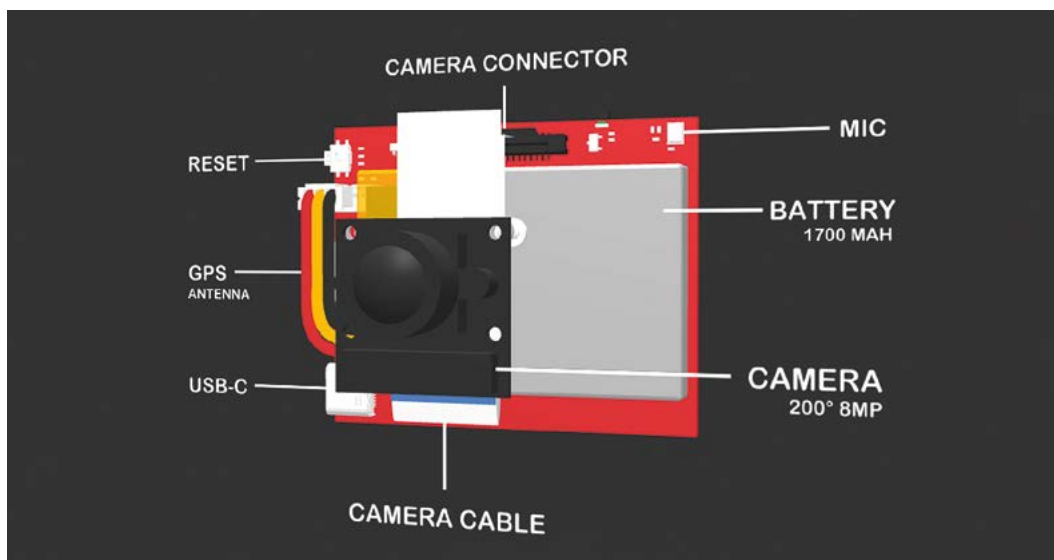

Verdict

Easy to use, but the videos produced aren't the best quality. It's still probably the best entry camera for VR360 videos that we've seen, though.

8/10

Your FREE guide to making a smart TV

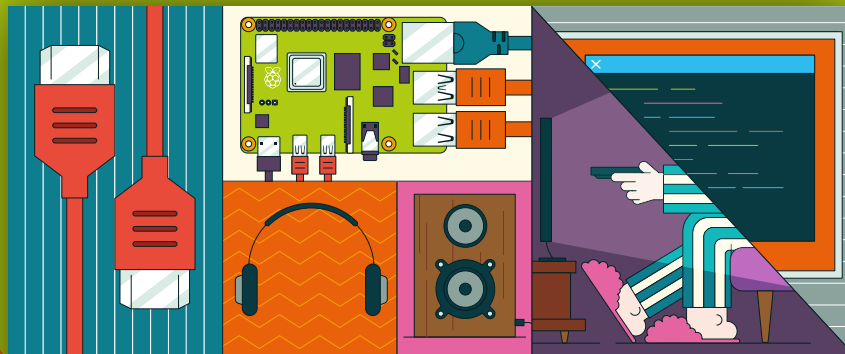

BUILD A RASPBERRY PI MEDIA PLAYER

Power up your TV and music system

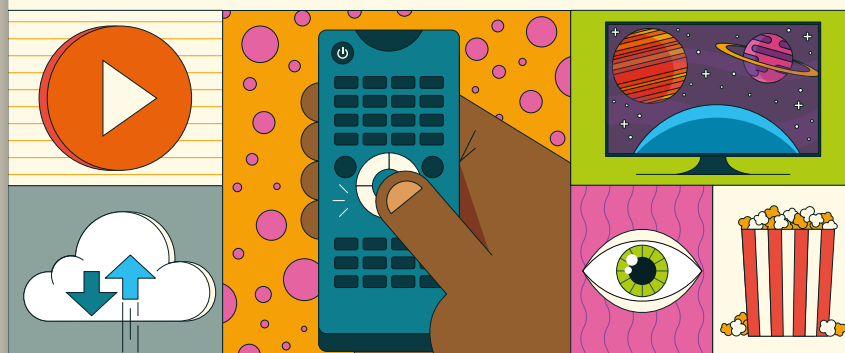

FROM THE MAKERS OF *MagPi* THE OFFICIAL RASPBERRY PI MAGAZINE

magpi.cc/mediaplayer

Inventor 2040 W

► Pimoroni ► magpi.cc/inventor2040w ► £35 / \$32

An all-in-one board with pre-soldered Pico W and myriad connections. By **Phil King**

With a Pico W pre-soldered to the board, the Inventor 2040 W combines several features of other, more specialised devices in Pimoroni's RP2040 range. For starters, you get six GPIO headers for input/output connections, including three connected to Pico's analogue input channels. Each three-pin (signal, power, ground) header also has its own addressable RGB status LED.

On the opposite side of the board are six more three-pin headers; these are for connecting servos. So you have enough for a robotic arm, for instance. Again, each header has an RGB LED.

There are two connectors for motors. Like those on the Motor 2040 (also reviewed this issue), these are of the six-pin JST-SH variety, requiring the use of motors equipped with MMMEs (micro

metal-gear motor encoders). The upside of this is that you get speed/rotation feedback data from each motor for high-precision control.

Very well connected

You also get very handy User and Reset buttons, two Qwiic / STEMMA QT ports, an I2C / Breakout Garden unpopulated header, and a welcome JST-PH input for optional battery power. In addition, there's a two-pin connector for the 1A 1.5W audio output; Pimoroni sells a tiny speaker that fits it.

“ Makes it simpler for beginners to get started with coding and electronics ”

Perhaps most importantly, there's the usual excellent software support for the board, including C++ and MicroPython libraries. The latter is particularly useful for simplifying control of things like servos, and comes with a good range of examples. Combined with the easy-to-use connections, this makes it simpler for beginners to get started with coding and electronics than just using a Pico on a breadboard.

Alternatively, you could opt for the Pico Explorer Base which has a mini LCD and standard two-pin motor connectors. **M**

SPECS

INPUTS/OUTPUTS:

6 × GPIO headers (including 3 × analogue inputs),
6 × servo headers,
2 × JST-SH (6-pin) motor ports,
2 × Qwiic / STEMMA QT ports, I2C / Breakout Garden header, JST-PH battery input, audio output

FEATURES:

12 × WS2812B RGB LEDs, User and Reset buttons, DRV8833 dual H-Bridge motor driver, motor direction LEDs

DIMENSIONS:

52 × 66 × 12 mm

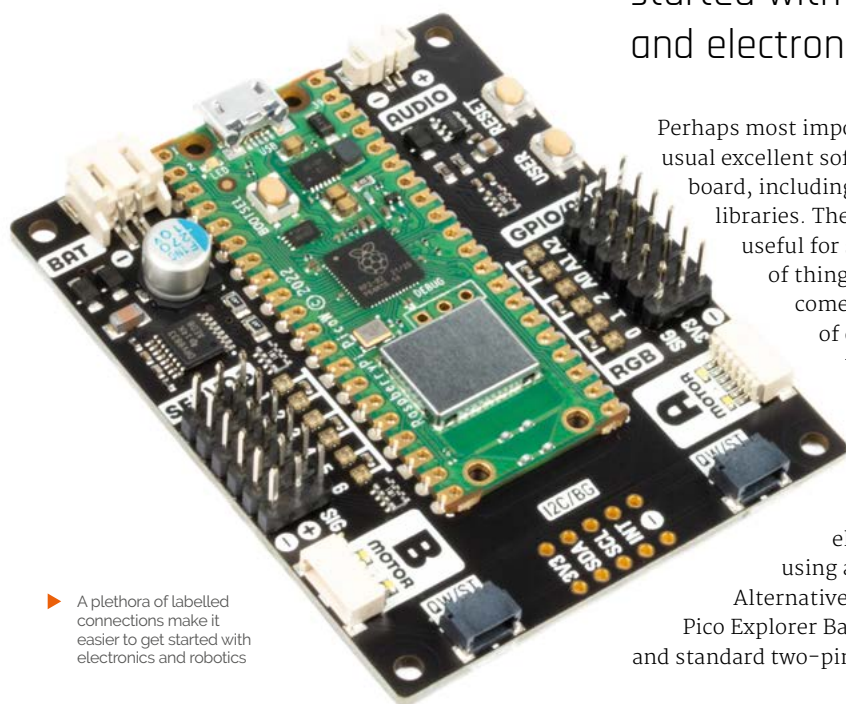

► A plethora of labelled connections make it easier to get started with electronics and robotics

Verdict

A good range of features and connections are complemented by excellent software support to make Pico electronics and robotics easier for beginners.

8/10

THE *Official*

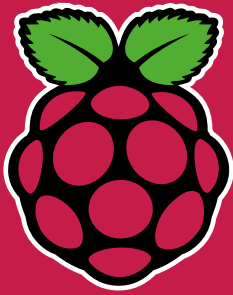

RASPBERRY PI HANDBOOK

2022

200 PAGES OF RASPBERRY PI

- QuickStart guide to setting up your Raspberry Pi computer
- Updated with Raspberry Pi Pico and all the latest kit
- The very best projects built by your Raspberry Pi community
- Discover incredible kit and tutorials for your projects

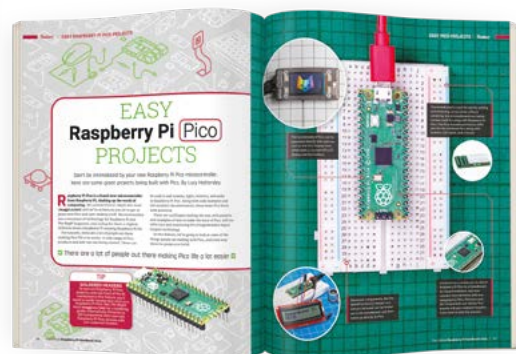
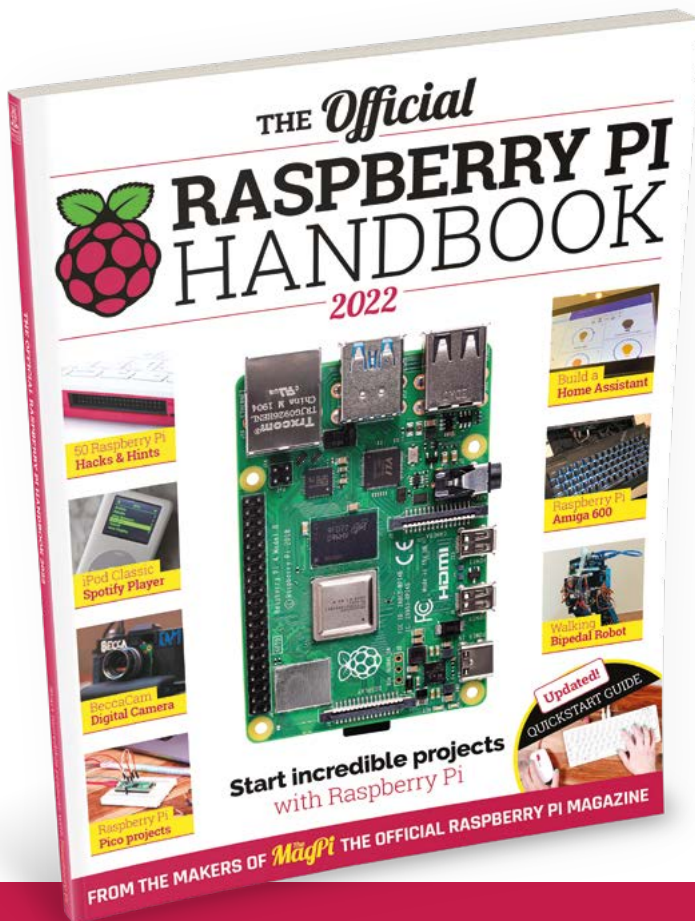

Buy online: magpi.cc/store

Motor 2040

► Pimoroni ► magpi.cc/motor2040 ► £24 / \$23

Control four motors independently with high precision. By **Phil King**

Already built a basic two-wheeled robot and want to step up to the next level? The Motor 2040 board is a neat option that offers quad motor control for four-wheel drive, along with precision control using speed encoders.

Based around an RP2040 microcontroller (as used in Raspberry Pi Pico), it packs a lot of powerful features into a tiny footprint, so you could use it on a mini robot chassis. The one caveat is that its four 6-pin JST-SH ports are designed to be connected to motors equipped with Pimoroni's MMEs (micro metal-gear motor encoders) – you can either buy motors with them pre-soldered or solder MMEs onto standard motors.

Getting feedback

What those speed encoders provide is feedback from the motors, so you know exactly how many times they've rotated. This enables super-precise control of the robot – or whatever you want to build, such as a pulley system. In addition, the independent four-wheel drive is ideal for using mecanum omnidirectional wheels that allow your

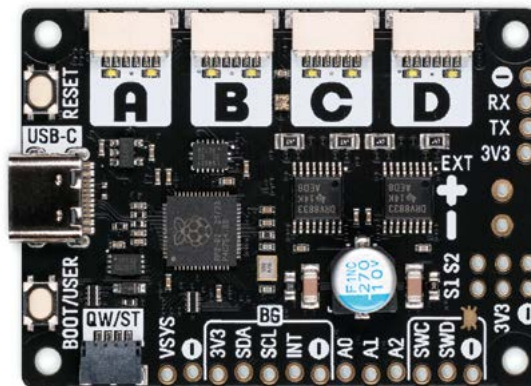

▲ Each of the four motor channels has two LEDs to indicate the current direction – forwards or backwards

robot to also move sideways. Built in current-, voltage-, and fault-monitoring should avoid any issues with motor burnout too.

Also on the Motor 2040 board, you'll find a single status RGB NeoPixel and individual LEDs to indicate each motor's direction – great for debugging your code, even without the motors

“ What those speed encoders provide is feedback from the motors ”

plugged in. Talking of coding, it uses a similar MicroPython library to Pimoroni's Motor SHIM for Pico (reviewed in issue 120, magpi.cc/120), but with extended functionality and plenty of examples. You can also use C++ or CircuitPython.

Bonus features on the Motor 2040 include Reset and Boot/User buttons, a Qwiic/STEMMA QT connector, and unpopulated breakout headers – including two sets for connecting analogue sensors. **M**

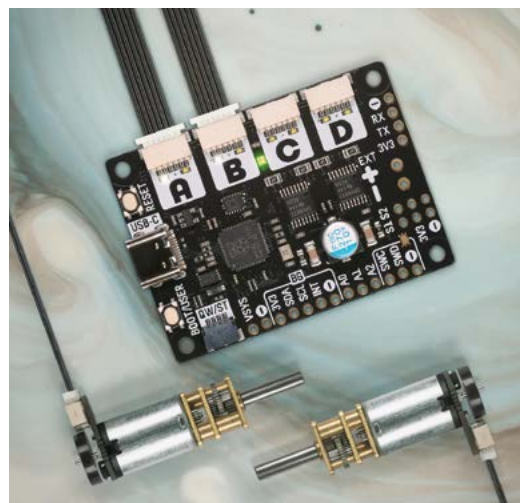

SPECS

POWER:

USB-C or EXT PWR / VSYS connections; 5V, or up to 13.2V (after cutting trace on rear)

MOTOR DRIVER:

2 × DRV8833 dual H-bridge for four motor channels

INPUTS/

OUTPUTS:

4 × JST-SH ports (6-pin), 1 × Qwiic/STEMMA QT port, unpopulated breakout headers

FEATURES:

Boot/User and Reset buttons, RGB status LED, 8 × direction indicator LEDs, voltage/current/fault sensing

Verdict

Slightly restricted by the use of special six-pin connectors, this is a compact, powerful driver board that's brimming with features at a good price.

8/10

CUSTOMPC

THE BEST-SELLING MAG FOR PC HARDWARE, OVERCLOCKING, GAMING & MODDING

THE MAGAZINE FOR

PC HARDWARE ENTHUSIASTS



ISSUE 232 OUT NOW

VISIT [CUSTOMPC.CO.UK](https://www.custompc.co.uk) TO LEARN MORE

10 Amazing: Holiday projects

Get festive this season with these incredible Raspberry Pi projects

As the nights gets colder, and the evenings grow darker, that can mean only one thing: it's time to get festive. Last month, we showed you how to make some tree lights with Pico, so here's a mixture of ten other excellent projects to check out. [📖](#)



▲ Santa Detector

Holly jolly alarm

A fun Scratch-based project so that younger makers can catch Santa red-handed. Will you be able to snare him before he escapes?

magpi.cc/santadetector



▲ NeoPixel Menorah

RP2040 mensch

Celebrate the eight days of Hanukkah with this electronic Menorah, created by the Ruiz brothers over at Adafruit using QT Py RP2040. 3D-printed dreidel not required, but you might as well.

magpi.cc/npmenorah



◀ Tree Star

Custom topper

A homemade tree topper using 3D-printed star parts. Originally made with a Raspberry Pi Zero, however, with a Raspberry Pi Pico and last month's tree lights feature, you could easily convert it to be Pico-powered.

magpi.cc/64

► Secret Santa Babbage

Keeper of names

Instead of drawing names, Babbage here will print out the name of your gift recipient to make sure everything is much more secure before the secretive gift giving.

magpi.cc/secretbabbage





▲ Naughty or Nice Machine

List checker

Using the magic of science, placing your hand in this machine will determine whether you're naughty or nice, and definitely doesn't give smaller hands a nice score to please kids.

magpi.cc/naughtynice

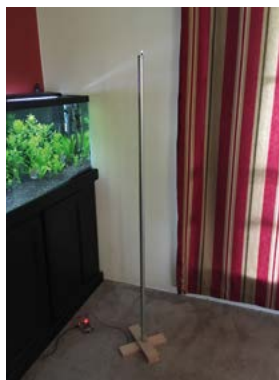

◀ IoT Festivus Pole

For the rest of us

Air your grievances around this Festivus pole on 23 December, declaring a Festivus miracle as the pole lights up whenever someone tweets out #Festivus or #FestivusMiracle.

magpi.cc/iotfestivus



▲ Virtual Fireplace

Roaring pixels

A different kind of Raspberry Pi fireplace, this one uses a screen and some clever woodwork to build a realistic fascia. It's much safer than a real fire too.

magpi.cc/virtualfire



▲ 3D Xmas Tree

Mini festive greenery

This project kit is a great stocking filler, or just something nice to have in your maker space, perhaps the one you built after reading our feature this issue.

magpi.cc/3dtree | £15 / \$17



▲ Minecraft-controlled Tree

Cross-reality interaction

We've seen projects that use Minecraft to activate real world things before, but controlling an entire tree with Minecraft is like some kind of magic. It's done as a game as well!

magpi.cc/xmasminecraft

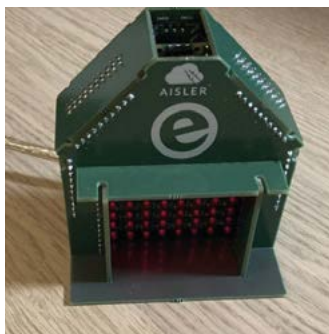

◀ DIY Christmas Fireplace

Pico puzzle box

This Pico-powered fireplace is also a small 3D puzzle made up of PCBs to simulate some roaring flames via LEDs. Fascia optional.

magpi.cc/picofire

HackSpace

TECHNOLOGY IN YOUR HANDS

THE **MAGAZINE**
FOR THE **MODERN MAKER**



SUBSCRIBE AND
SAVE UP TO
35%
on the cover price



ISSUE #61

OUT NOW

hsmag.cc



Learn to code games with Raspberry Pi

Resources to help you start creating your own games. By **Phil King**

Invent Your Own Computer Games With Python

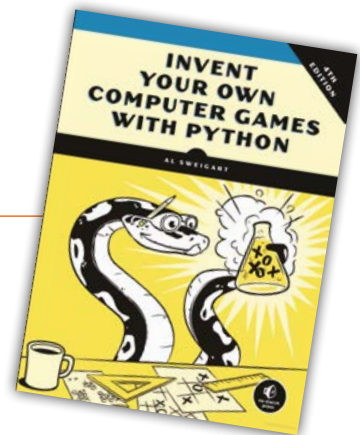

AUTHOR

No Starch Press

Price:
£25 / Free (online)
[magpi.cc/
inventgames](http://magpi.cc/inventgames)

Having played a fair few computer games, many of us may well have come up with a great idea for a new one.

But how can we get started making it a reality? For novice coders, Python is an ideal starting point as it's fairly easy to learn and is one of the world's most widely used programming languages.

Also available to read online for free, Al Sweigart's book (now in its fourth edition) aims to help even complete novices get started with Python to code games. While it starts with the basics and some very simple games, such as guessing a hidden number, it follows an accessible learning curve that teaches key programming

concepts along the way and leads to the creation of increasingly sophisticated games. The last few chapters cover creating graphics and animating them using the Pygame module, culminating in a 'Dodger' game featuring sprites, collision detection, and sound effects. 

Bookmark these

Learn to create games via these websites

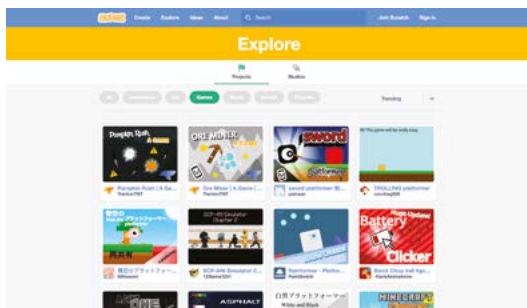

SCRATCH

For younger coders in particular, Scratch's block-based approach makes it easy to create programs, including games. Get some inspiration from some of the existing titles made by users.

► scratch.mit.edu

PI GAME DEV

Created specifically for those seeking to make games on Raspberry Pi, this online hub

features useful links to all the best game engines, art tools, art assets, and music/audio resources.

► pygame.dev

ITCH.IO

Once you've created a great game, why not upload it to the Itch.io online marketplace for indie developers? You can set a minimum price, or let people download it for free.

► itch.io

Code The Classics – Volume 1

AUTHOR

Raspberry Pi
Press

Price:
£12 / Free (PDF)

magpi.cc/ctcbook1

This 224-page hardback book (also available as a free PDF) covers the history and development of five classic games from the 1970s and 1980s, each representing a different genre.

While that's fascinating reading in itself, each chapter also features a detailed guide on how to create a game in that genre using Python and Pygame Zero. The latter enables the creation of games with zero boilerplate code at the start, so there's a lot less faff.

Starting off with Pong (tennis), one of the simplest games to replicate, it

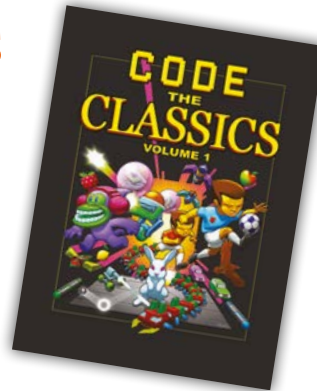

moves on to cover Bubble Bobble (action platformer), Frogger (top-down platformer), Centipede (fixed shooter), and Sensible Soccer (football). Each project explores key coding concepts related to game development, along with a full code listing – which can be downloaded along with the graphics and sounds. 

Recommended reading

Books to help you learn to make games



PYTHON, PYGAME, AND RASPBERRY PI GAME DEVELOPMENT

Covering concepts such as object-oriented programming and design patterns, Sloan Kelly's guide shows you how to code several games and even connect external controls via the GPIO pins.

► magpi.cc/pprpgames

ADVENTURES IN MINECRAFT 2ND EDITION

By writing Python programs, you can modify the Minecraft world to create a whole new experience. This book shows you how to do it and write a complete interactive arena game.

► magpi.cc/advminecraft2nd

RETRO GAMING WITH RASPBERRY PI 2ND EDITION

As well as covering how to play retro games on Raspberry Pi, and even build an arcade machine, this book includes a tutorial series on how to create your own games using Python and Pygame Zero.

► magpi.cc/retrogaming2nd

PICO-8

AUTHOR

Lexaloffle

Price:
\$14.99

magpi.cc/pico8

Computer games programmers of the 1980s had to work within the tight restraints of 8-bit hardware, leading them to focus on creating fun gameplay. No wonder retro-style games are still so popular,

and you can create your own with the PICO-8 virtual console – it'll run on any system, including Raspberry Pi.

As well as enabling you to play thousands of games created by its community, many of which are highly polished, PICO-8 comes with a suite of tools – for editing code (in the Lua language), music, sound, sprites, and maps – to help you make your own. Check out our six-part tutorial series starting in issue 83 (magpi.cc/83). Once you've finished your masterpiece, you can share it with others and also export it as a stand-alone HTML5, Windows, Mac, or Linux app. 





Toby Roberts

Ex-policeman and now a maker at Raspberry Pi, who is Toby Roberts?

- ▶ Name **Toby Roberts** | ▶ Occupation **Maker-in-residence**
- ▶ Community role **Maker** | ▶ Twitter **@TobyRobertsPi**

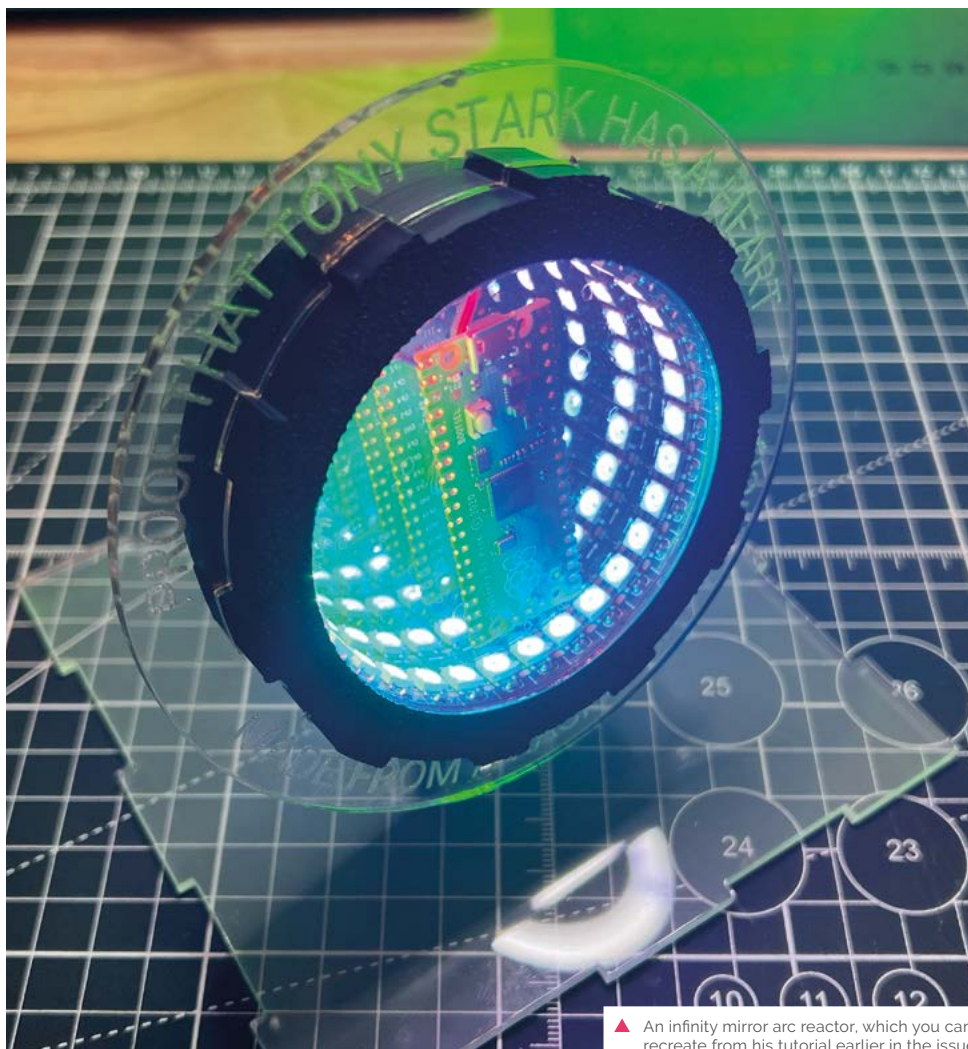

▲ An infinity mirror arc reactor, which you can recreate from his tutorial earlier in the issue

Like many people with a Raspberry Pi, Toby Roberts' entry into the world of our favourite microcomputer was via a media centre build. He'd been building and making as part of his job long before that though.

"I used to be a police officer tackling serious organised crime and terror threats across the east of the UK," Toby tells us. "I was a Technical Surveillance Officer for 15 years, so I built stuff to hide video, audio, and other covert gear. You really don't want your sensitive police equipment discovered, so I'd disguise it as something else, like a piece of street furniture or a household item. The variety of tools and equipment I used then really shaped what I do today."

When did you learn about Raspberry Pi?

I started playing with Raspberry Pi hardware at home around the same time I started using Linux at work. I have used Raspberry Pi a lot in various police tactics over the years. They were dependable, low-cost, portable, and supported by such an awesome community. I tried almost every 'fruit-based'

single-board computer out there, but I always came back to Raspberry Pi.

What's it like working at Raspberry Pi?

While I enjoyed my time in the police, it was tough at times, so it's really pleasant now to be in such a joyful environment. During all those years of working with Raspberry Pi, I never thought I'd end up working here; as I've always been a Raspberry Pi fan, I'm fascinated to see what takes place behind the scenes. I'm now a small part of its future, which is amazing!

What have been some of your favourite projects?

I really enjoyed designing and building my own 3D printer, which I named Krane. For my computer-aided design work, I used Fusion 360, which has a steep learning curve but is fantastic for 3D printing. The whole concept of using 3D printing to make other 3D printers is lots of fun. I added

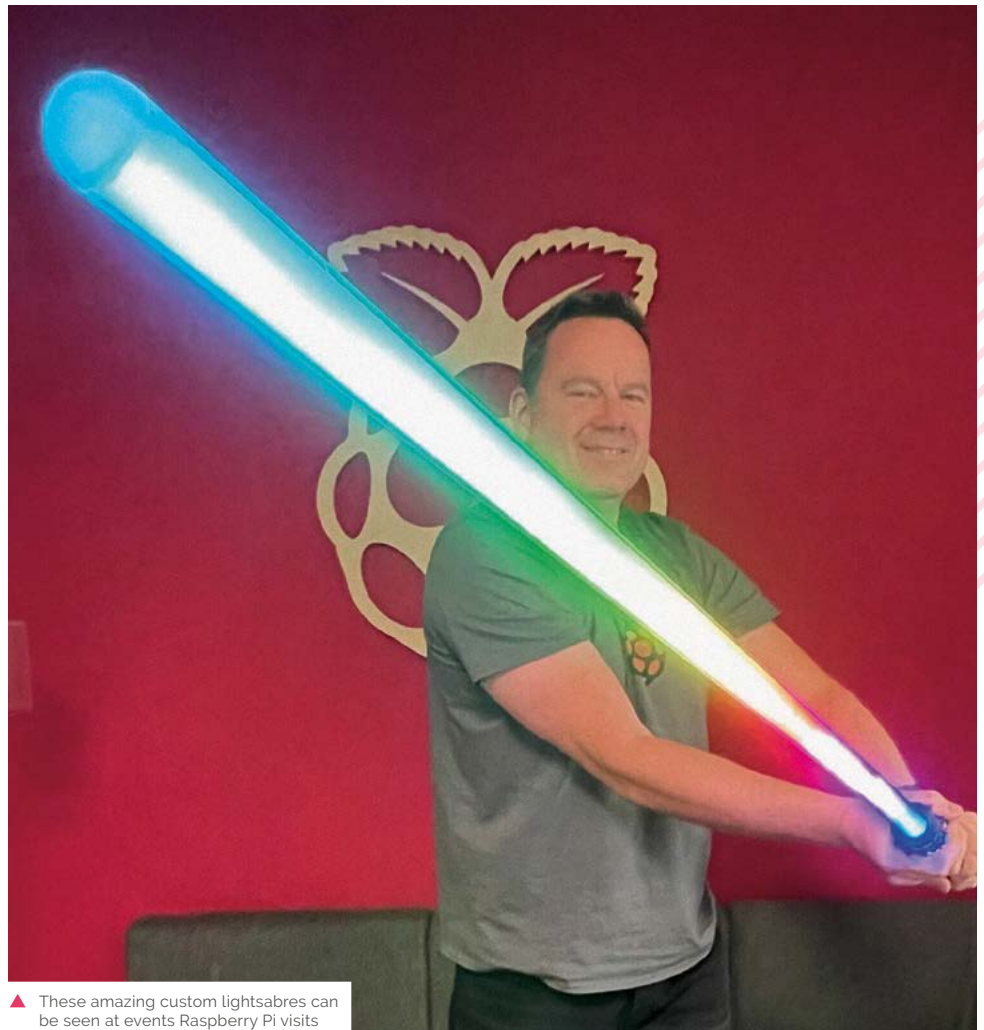

▲ These amazing custom lightsabres can be seen at events Raspberry Pi visits

“ I love 3D printing and design. I have three FDM printers and one SLA printer ”

a Raspberry Pi with a screen so that OctoPrint could be run from it. Even though 3D printers are relatively inexpensive, making one from scratch is very rewarding. 3D printing is an excellent hobby that pairs perfectly with many Raspberry Pi projects.

SLA printer. I also have a laser cutter and a CNC machine. They have all been put to practical use on Raspberry Pi projects like RP2040-based lightsabres, Raspberry Pi Pico Iron Man reactors, and even an automated swear box for the office – just for the giggles. ”



▲ Toby's custom 3D printer has been used for many amazing projects in the office, and was used for our Poltergust G-00 tutorials

What other hobbies do you have?

In the past, I flew drones for the police, and I still enjoy building and flying them. I love 3D printing and design. I have three FDM printers and one

See Toby's work

As well as seeing Toby's stuff on the Raspberry Pi blog and his social media, a lot of what he does ends up on the Raspberry Pi TikTok as well! Go check it out there for more fun pictures and videos: [tiktok.com/@raspberrypi](https://www.tiktok.com/@raspberrypi)

MagPi Monday

Amazing projects direct from our Twitter!

Every Monday we ask the question: have you made something with a Raspberry Pi over the weekend? Every Monday, our followers send us amazing photos and videos of the things they've made.

Here's a selection of some of the awesome things we got sent this month – and remember to follow along at the hashtag #MagPiMonday! 📷

01. Returning to LEGO bases for Raspberry Pi projects is always a welcome sight
02. This is Galactica actual, and we're getting ready to spool up the FTL drivers
03. Definitely an interesting way to improve your monitoring system – we've seen projects that link this to locks as well, so known people can enter
04. The colours from this Pimoroni kit are very pretty
05. A Burger Bot from a different maker! Kevin's builds are spreading
06. A very cool project for a worthy cause
07. We've seen a lot of cheerlights activity recently – it's great to see people using it for project testing!
08. This is fantastic in action – looks like a mix of rain or snow! Great work
09. This robot dog is adorable, and we love that it's based on the CamJam Edu Kit 3
10. We were completely wowed by this, and we think Boimler would be too. Cali class are tough ships
11. We're always amazed at how much an RP2040 can do

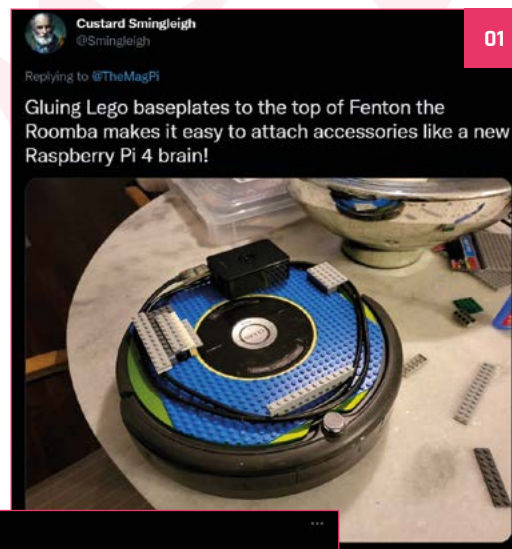

Kevin McAleer @kevmac
Robot Maker

04

Replying to @TheMagPi

Happy #MagPiMonday - this weekend I've been playing with the new @pimoron Wireless Plasma Kit - Skullly edition. It has a Raspberry Pi Pico aboard the Plasma Stick 2040 W and you can easily program it to do lots of fun colour patterns in #Circuitpython or #MicroPython #Halloween



Rory Steel @JerseyTGay

05

Replying to @TheMagPi

I've been making a #lascut version of @kevmac's #BurgerBot to take into schools for a new @Raspberry_Pi based #PicoW based curriculum. #Networking #coding #3Dprinting #electronics #STEM #FUN.

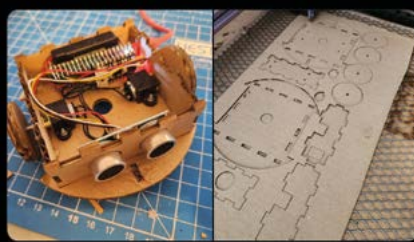

Brian Cortell @CannonFoder

06

Replying to @TheMagPi

Inspired by a question on #MakersHour and my first Raspberry Project, I fell into a rabbit hole, trying to create an IoT(Internet of things) event signal for the hard of hearing. So far I have come up with this Pico W project. Linked to my Ring doorbell motion event #MagPiMonday



Simon Prickett @simon_prickett

07

Replying to @TheMagPi

I got a Unicorn Hat on a Pi 3 showing recent @cheerlights colours from a Redis stream.



Dr Footleg - Roboteer @drfootleg@fosstodon.org @drfootleg

08

Replying to @TheMagPi

I wrote a pixel rain demo for my LED animations library. Running on a Raspberry Pi 4 here using my own designed HAT and power board to drive 6 LED matrix panels. #MagPiMonday

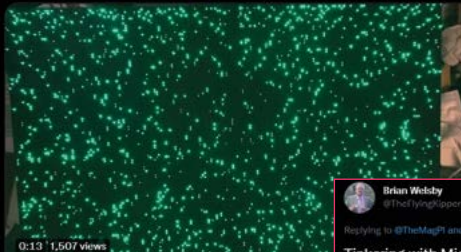

Pater Practicus @PaterPracticus

09

Replying to @TheMagPi

K-V, the @Raspberry_Pi powered @CambridgeJam kit is coming on. Sensors to be added next. #MagPiMonday



James @rasppjamberlin @mickymadame

10

Replying to @TheMagPi

@meWho_System47 has made this wonderful Star Trek Lower decks Cerritos LCARS website (check it out here: mewho.com/ritos/). With Rob's help we got the site hosted on a @Raspberry_Pi, connected to LEDs and synced using web-sockets. Check out the video!

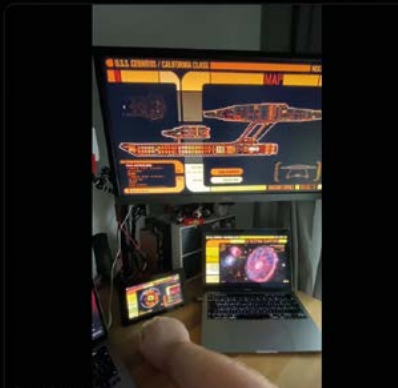

Brian Weldby @TheTyingKipper

11

Replying to @TheMagPi and @Raspberry_Pi

Tinkering with MicroPython on a Pimoron Tufty RP2040 based display



Halloween Aftermath

Spooky projects from around the community that are sure to give you a fright

Halloween has just passed here as we write this, which means people have been showcasing some mortifying makes that they used for the hallowed day of witches, ghouls, and vampires. Prepare yourself... 

01. Spooky eyes are scary! Spooky eyes that track you? Even spookier
02. Bare Bones, ah, we see. A pun scarier than any skeleton
03. Is a GhostBox what they use on those ghost hunter shows or in Phasmophobia?
04. We wanted spooky projects but we'll take a cute ghost
05. It was very foggy around Halloween where we were, but hopefully this was needed for Cellar Nerd
06. Is there anything spookier than a Minion?
07. Daniel has been working on a lot, but that Halloween skull looks terrifying

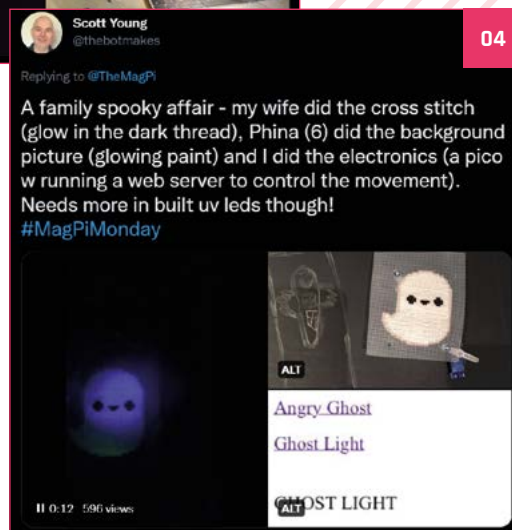
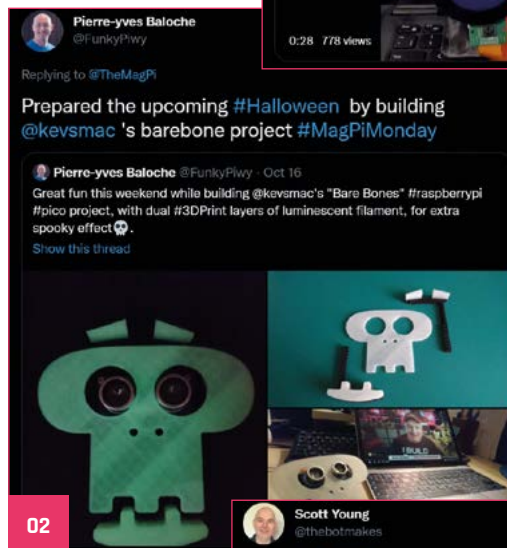

05

Cellar Nerd @CellarNerd

Replying to @TheMagPi

A few hours after the kids are done trick or treating, the fog machine is finally controlled by a #PicoW.

Cellar Nerd @CellarNerd · Oct 31

Guess who's got a fog machine controlled by a @Raspberry_Pi #PicoW over #MQTT triggered by @home_assistant? A few hours too late for this #halloween, but now I've got almost a year to finish the enclosure and fine tune the programming 😊



06

AxWax (@axwax@fosstodon.org) @AxWax

Replying to @TheMagPi

I didn't want to miss out on all the spooky eyeball fun everyone seems to be having, so I had a go at adapting one of @todbot's recent projects to run on @pimoroni's Round LCD Breakout on the @Raspberry_Pi Pico using @micropython.

#MagPiMonday



Daniel Quadros @DQSoft

Replying to @TheMagPi

07

IP display in an old Rasp Pi 1, Halloween skull with a Xiao RP2040 and a frequency display for a signal generator using a RP2040 Zero. Very busy week!



Crowdfund this!

Raspberry Pi projects you can crowdfund this month



Mini Pupper 2

We liked Mini Pupper, so it's very cool to see that there will be a second, upgraded version with smarter servos and even better code to make it better than ever. It has an impressive list of new features, such as a microphone, speaker, auto calibration, and a mobile app you can use to control it.

► kck.st/3ENnRhh



Christmas Tree PCB

There's a few Raspberry Pi-powered Xmas tree projects but this is one of the first we've seen with a Pico. The whole project is pretty cheap and already hit its funding goal, so it's a good time to jump on and get one as a decoration this December.

► kck.st/3z6tXWq

Your Letters

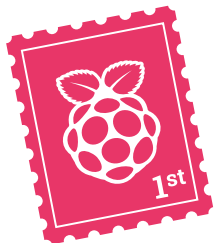

Rover where

Years ago, in one of your early issues, there was a rover project that I would like to recreate. I'm thinking 2016 or so, as I think it was built on a Raspberry Pi 1 with 26 GPIO pins. Can't seem to find it now, so any help would be appreciated. It was the only one I have found that has a web page interface for video.

Tony via email



▲ This robot ended up as the base for the Tiny 4WD kit that Core-Tec sells

The big robot we made in 2016 is issue 38's budget robot that used an A+ as a chassis, so that would have been 40 pins, and it didn't have a camera for a web interface. A robot that should fit the bill for what you remember is the Tiny 4WD that we built in issue 50 and 51 (magpi.cc/50, magpi.cc/51). That used a camera and was a pretty exhaustive robot guide.

The software for this was made with code from the, now defunct, Dawn Robotics. However, you can find the code here: bitbucket.org/DawnRobotics.

Contact us!

- Twitter [@TheMagPi](https://twitter.com/TheMagPi)
- Facebook [magpi.cc/facebook](https://facebook.com/magpi)
- Email magpi@raspberrypi.com
- Online forums.raspberrypi.com

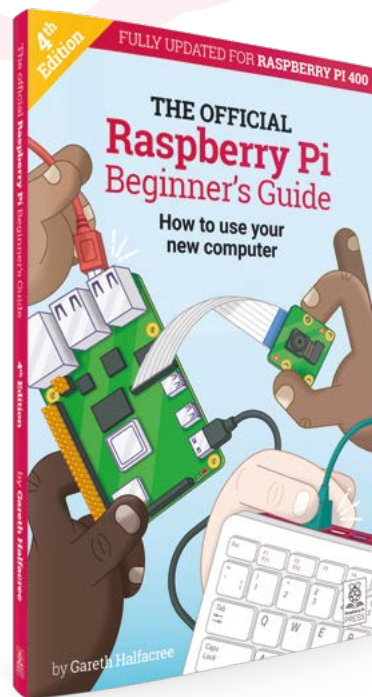

▲ You can also grab our Raspberry Pi Beginner's Guide book from here: magpi.cc/beginnersguide

New user

I've been reading your magazine for a few issues now, and I am planning on getting a Raspberry Pi and all the trimmings for Christmas – are you planning any new beginner guides in the magazine? What about projects for beginners? I'm hoping for an up to date article or two, if that's possible.

SeriK via Twitter

You're in luck, as our very next issue is going to include a beginners' guide for new users! We also try to make sure that we have a nice spread of beginners stuff and advanced tutorials in the magazine, so hopefully from next month, when you have your Raspberry Pi, you'll be able to jump into some fun projects!

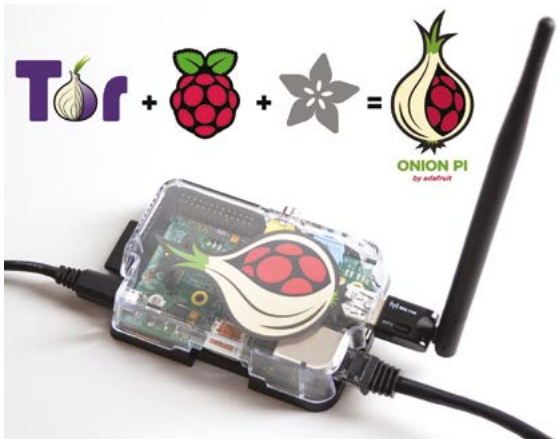
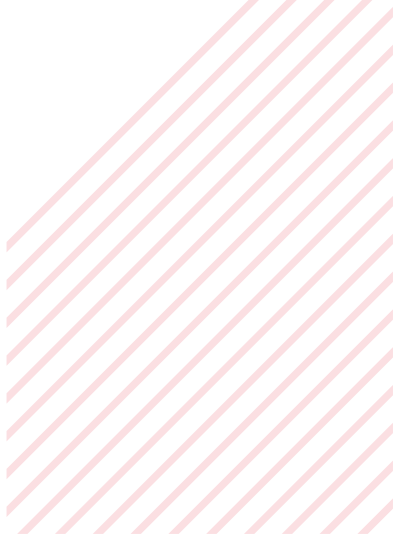

▲ People have been using Raspberry Pi as an access point since the very start, so it's luckily well-documented

Access Point

How can I build an own WLAN network (not connect to an existing one)? I'm building a robot car which I can steer via WLAN.
I want to drive the car when I'm not on my own home network. Via Google, I didn't find a way of how to set up software on Raspberry Pi OS to deliver a WLAN network.

Jürgen via email

For something like this, you're trying to turn Raspberry Pi into an access point – that way you can use a browser on a mobile phone, laptop, or any portable computing device to connect directly to Raspberry Pi.
You can find out many more details on how to do this officially in the documentation (magpi.cc/apdocs) and, for something a little more focussed towards what you'd want to do, you could always follow this informative tutorial: magpi.cc/apguide.

3 ISSUES FOR £10



☎ Subscribe by phone:
01293 312193

🌐 Subscribe online:
magpi.cc/subscribe

✉ Email: magpi@subscriptionhelpline.co.uk

Subscribe for £10 is a UK-only offer. The subscription will renew at £15 every three months unless cancelled. Free Pico W included with a 6-month subscription in USA, Europe and Rest of World. This is a limited offer. Not included with renewals. Offer subject to change or withdrawal at any time.

Wireframe

Join us as we lift the lid
on video games

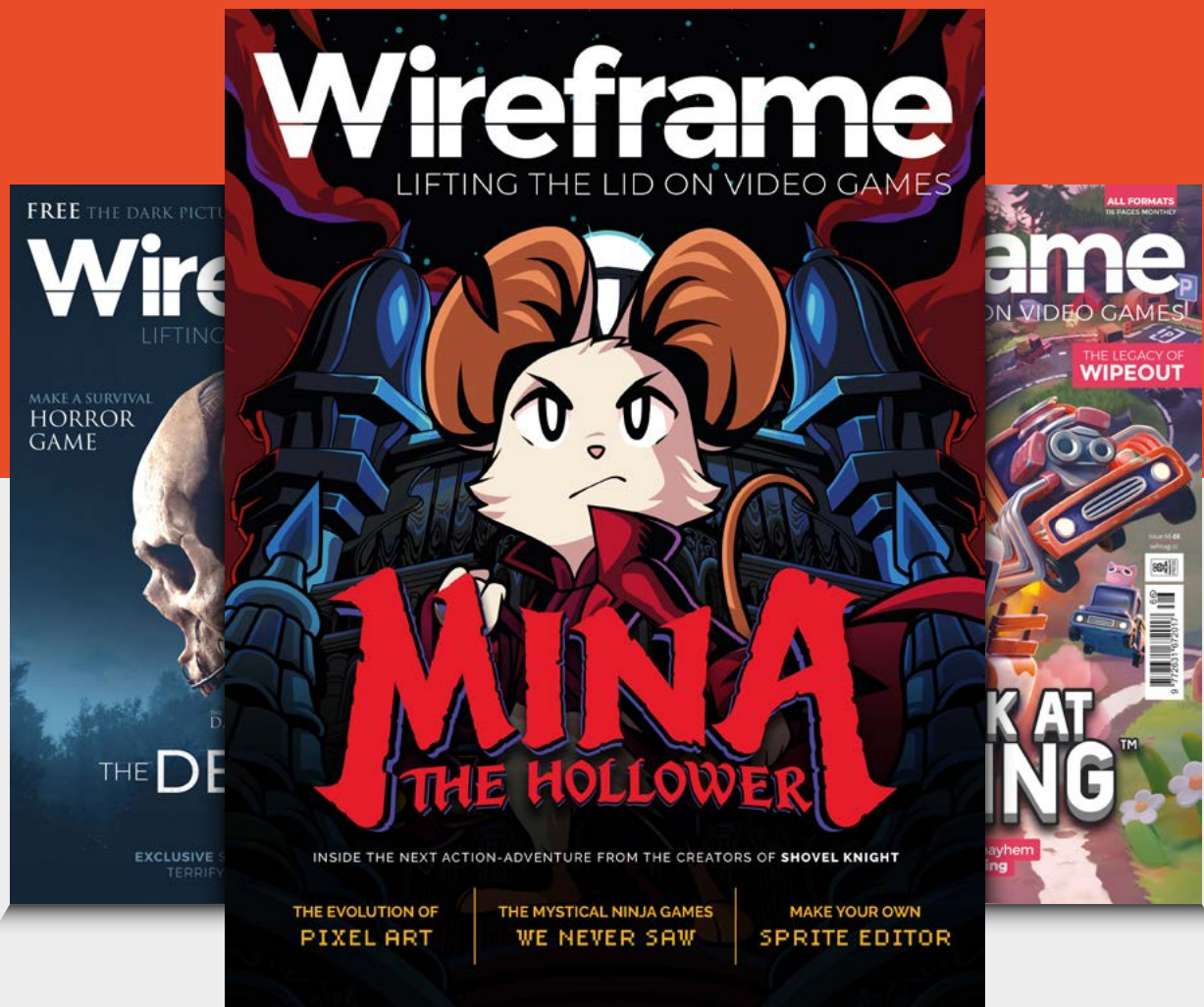

Visit wfmag.cc to learn more

WIN

A MICROPI STARTER KIT

A fantastic robotics and computer kit that helps teach coding and programming. We reviewed it last issue, gave it a 10/10, and now we have one to give away!



Head here to enter: magpi.cc/win | Learn more: micropi.org

Terms & Conditions

Competition opens on **23 November 2022** and closes on **15 December 2022**. Prize is offered to participants worldwide aged 13 or over, except employees of Raspberry Pi Ltd, the prize supplier, their families, or friends. Winners will be notified by email no more than 30 days after the competition closes. By entering the competition, the winner consents to any publicity generated from the competition, in print and online. Participants agree to receive occasional newsletters from The MagPi magazine. We don't like spam: participants' details will remain strictly confidential and won't be shared with third parties. Prizes are non-negotiable and no cash alternative will be offered. Winners will be contacted by email to arrange delivery. Any winners who have not responded 60 days after the initial email is sent will have their prize revoked. This promotion is in no way sponsored, endorsed or administered by, or associated with, Instagram, Facebook, Twitter or any other companies used to promote the service.

English not your mother tongue?

The MagPi is also available in German!



Subscribe to the German edition of The MagPi and get a Raspberry Pi Pico with headers and a cool welcome box **FOR FREE!**

Use the coupon code **115PicoDE** on www.magpi.de/115



NEXT MONTH | *MagPi*

RASPBERRY PI & PICO

STARTER GUIDE

LET'S GIVE NEWCOMERS A HELPING HAND!



WITH
COMMAND
LINE
BASICS!

THE MAGPI #125
ON SALE 15 DEC

Plus!

A Ukrainian Geiger counter

Miniature Mars rover

Running in Kiosk mode

DON'T MISS OUT!
magpi.cc/subscribe

TWITTER @TheMagPi

FACEBOOK fb.com/MagPiMagazine

EMAIL magpi@raspberrypi.com

EDITORIAL

Editor

Lucy Hattersley
lucy@raspberrypi.com

Features Editor

Rob Zwetsloot
rob@raspberrypi.com

Sub Editor

Nicola King

ADVERTISING

Charlotte Milligan
charlotte.milligan@raspberrypi.com
+44 (0)7725 368887

DESIGN

criticalmedia.co.uk

Head of Design

Lee Allen

Designers

Olivia Mitchell, Sam Ribbits

Illustrator

Sam Alder

CONTRIBUTORS

Brendan Charles, David Crookes, Rosemary Hattersley, Nicola King, Phil King, KG Orphanides, Toby Roberts

PUBLISHING

Publishing Director

Russell Barnes
russell@raspberrypi.com

Director of Communications

Liz Upton

CEO

Eben Upton

DISTRIBUTION

Seymour Distribution Ltd
2 East Poultry Ave,
London EC1A 9PT
+44 (0)207 429 4000

SUBSCRIPTIONS

Unit 6 The Enterprise Centre
Kelvin Lane, Manor Royal,
Crawley, West Sussex, RH10 9PE
+44 (0)1293 312193
magpi.cc/subscribe
magpi@subscriptionhelpline.co.uk



This magazine is printed on paper sourced from sustainable forests and the printer operates an environmental management system which has been assessed as conforming to ISO 14001.

The MagPi magazine is published by Raspberry Pi Ltd, Maurice Wilkes Building, St. John's Innovation Park, Cowley Road, Cambridge, CB4 0DS. The publisher, editor, and contributors accept no responsibility in respect of any omissions or errors relating to goods, products, or services referred to or advertised in the magazine. Except where otherwise noted, content in this magazine is licensed under



a Creative Commons Attribution-NonCommercial-ShareAlike 3.0 Unported (CC BY-NC-SA 3.0). ISSN: 2051-9982.



Community

Maintaining one of the best parts of using Raspberry Pi

By **Rob Zwetsloot**

Being part of the community is one of my favourite things about working on *The MagPi*, and for Raspberry Pi in general. There are many very kind and very smart folks that love to show off what they can do with Raspberry Pi, or Raspberry Pi Pico, and help others if they can as well. It's nice to be a part of it.

However, as I write this, the future of a certain bird-themed social media service seems a little uneasy. While many refer to it as 'The Hellsite' (for very valid reasons) in my personal life, and professional life, I've had a lot of fun with it and made many great connections. I love starting Monday (or Tuesday, if there is a bank holiday) asking what you're making and seeing all the cool stuff fill up *The MagPi*'s mentions. It's hard to dislike Mondays like that.

It's everywhere

That place is not the only one that's full of Raspberry Pi or maker folks. The forums at Raspberry Pi (magpi.cc/forum) are full of great people working out some of the cooler

intricacies of Raspberry Pi, Pico, or even Raspberry Pi OS. Many a search to fix a project has landed me on the forum, with a solution right there, or a fantastic hint that gets me to one.

While unofficial, the subreddit for Raspberry Pi is always cool to look over. I've had many ideas for projects from there, and even got several people in the mag because they've posted to the subreddit. It's always fun

“ Many a search to fix a project has landed me on the forum, with a solution right there ”

to notice trends in projects as well, and of course see someone else making yet another interesting handheld retro gaming console in a new way I'd never considered.

Ashley, from the social team at Raspberry Pi, also tells me that

LinkedIn is great, however I try to avoid it for a very personal reason: I hate it. If you don't hate it though, go give Raspberry Pi a follow there, and also on Facebook. We're also on Facebook too!

Where next?

Hopefully by the time you read this, the fears over the bird app will have all (thankfully) come to nothing and service will resume as normal. In case it doesn't though, Raspberry Pi has launched its own Mastodon server at raspberrypi.social, and we at *The MagPi* will likely follow suit. Otherwise, Raspberry Pi is also exploring braver, younger frontiers with videos on TikTok.

Of course, the magazine will still be published, and I'm sure we'll find you all again, wherever we end up. [M](https://magpi.cc)

AUTHOR

Rob Zwetsloot

Rob likes to fire off pointless thoughts at 280 characters or less - feasibly too much. He has gone out in search of grass.

magpi.cc

HiPi.io

HIGHPI PRO

•———— The new case from the HiPi.io team ————•



- Rapid tool-free assembly and disassembly
- Large internal volume for HATs
- Compatible with Pi 2/3/4
- Multiple lid options
- Passive & Active Cooling options
- Secure microSD card cover
- VESA mount support
- Molding-configurable output ports customizable for volume orders
- Printed logo for your branding

Available at these great Pi stores:



Contact your favorite Pi store if it's not listed here

PiKVM

Manage your servers or workstations remotely

A **cost-effective** solution for data-centers, IT departments or remote machines!



PiKVM HAT
for DIY and custom projects



Pre-Assembled version

- Real-time clock with rechargeable super capacitor
- OLED Display
- Bootable virtual CD-ROM & flash drive
- Serial console
- Open-source API & integration
- Open-source software

Available at the main Raspberry Pi resellers



Reseller suggestions and inquiries:
wholesale@hipi.io